

# User Manual

## Hybrid Inverter

MG5/6/8/10/12RL



---

# All Rights Reserved

## All Rights Reserved

No part of this document can be reproduced in any form or by any means without the prior written permission of Sungrow Power Supply Co., Ltd (hereinafter "SUNGROW").

## Trademarks

**SUNGROW** and other SUNGROW trademarks used in this manual are owned by SUNGROW.

All other trademarks or registered trademarks mentioned in this manual are owned by their respective owners.

## Software Licenses

- It is prohibited to use data contained in firmware or software developed by SUNGROW, in part or in full, for commercial purposes by any means.
- It is prohibited to perform reverse engineering, cracking, or any other operations that compromise the original program design of the software developed by SUNGROW.

# About This Manual

The manual mainly contains the product information, as well as guidelines for installation, operation, and maintenance. The manual does not include complete information about the photovoltaic (PV) system. Readers can get additional information at [www.sungrowpower.com](http://www.sungrowpower.com) or on the webpage of the respective component manufacturer.

## Validity

This manual is valid for the following model of inverters:

- MG5RL
- MG6RL
- MG8RL
- MG10RL
- MG12RL

It will be referred to as "inverter" hereinafter unless otherwise specified.

## Target Group

This manual is intended for professional technicians who are responsible for installation, operation, and maintenance of inverters, and users who need to check inverter parameters.

The inverter must only be installed by professional technicians. The professional technician is required to meet the following requirements:

- Know electronic, electrical wiring and mechanical expertise, and be familiar with electrical and mechanical schematics.
- Have received professional training related to the installation and commissioning of electrical equipment.
- Be able to quickly respond to hazards or emergencies that occur during installation and commissioning.
- Be familiar with local standards and relevant safety regulations of electrical systems.
- Read this manual thoroughly and understand the safety instructions related to operations.

## How to Use This Manual

Please read this manual carefully before using the product and keep it properly at a place for easy access.

All contents, pictures, marks, and symbols in this manual are owned by SUNGROW. No part of this document may be reprinted by the non-internal staff of SUNGROW without written authorization.

Contents of this manual may be periodically updated or revised, and the actual product purchased shall prevail. Users can obtain the latest manual from [support.sungrowpower.com](http://support.sungrowpower.com) or sales channels.

## Security Declaration

For details on the product's network security vulnerability response process and vulnerability disclosure, please visit the following website: <https://en.sungrowpower.com/security-vulnerability-management>.

For more information on network security, please refer to the user manual of the communication module or the Data Logger that comes with the product.

## Symbols

This manual contains important safety instructions, which are highlighted with the following symbols, to ensure personal and property safety during usage, or to help optimize the product performance in an efficient way.

Please carefully understand the meaning of these warning symbols to better use the manual.

### **DANGER**

Indicates high-risk potential hazards that, if not avoided, may lead to death or serious injury.

### **WARNING**

Indicates moderate-risk potential hazards that, if not avoided, may lead to death or serious injury.

### **CAUTION**

Indicates low-risk potential hazards that, if not avoided, may lead to minor or moderate injury.

### **NOTICE**

Indicates potential risks that, if not avoided, may lead to device malfunctions or financial losses.



“NOTE” indicates additional information, emphasized contents or tips that may be helpful, e.g., to help you solve problems or save time.

# Contents

---

All Rights Reserved.....	I
About This Manual.....	II
<b>1 Safety Instructions.....</b>	<b>1</b>
1.1 Unpacking and Inspection.....	2
1.2 Installation Safety.....	3
1.3 Electrical Connection Safety.....	3
1.4 Operation Safety.....	5
1.5 Maintenance Safety.....	6
1.6 Disposal Safety.....	7
<b>2 Product Description.....</b>	<b>8</b>
2.1 System Introduction.....	8
2.2 Product Introduction.....	9
2.3 Symbols on the Product.....	10
2.4 LCD Screen.....	11
2.5 DC Switch.....	14
2.6 PV Energy Storage System (PV ESS).....	14
2.6.1 PV Energy Storage System (PV ESS).....	14
2.6.2 Declaration For Backup Function.....	19
2.7 Retrofitting the Existing PV System.....	20
<b>3 Function Description.....</b>	<b>22</b>
3.1 Safety Function.....	22
3.1.1 Protection.....	22
3.1.2 Earth Fault Alarm.....	22
3.2 Energy Conversion and Management.....	22
3.2.1 Power Derating.....	22
3.2.2 Regular Operational Voltage Range.....	22
3.2.3 Regular Operational Frequency Range.....	23
3.2.4 Reactive Power Regulation.....	23
3.2.5 Load Control.....	23
3.3 Communication and Configuration.....	23
3.4 Import Power Limit Function.....	23
3.5 PID Zero.....	24
3.6 Battery Management.....	25
<b>4 Unpacking and Storage.....</b>	<b>27</b>

4.1 Unpacking and Inspection.....	27
4.2 Scope of Delivery.....	28
4.3 Inverter Storage.....	30
<b>5 Mechanical Mounting.....</b>	<b>32</b>
5.1 Safety During Mounting.....	32
5.2 Location Requirements.....	33
5.2.1 Installation Environment Requirements.....	33
5.2.2 Carrier Requirements.....	34
5.2.3 Angle Requirements.....	35
5.2.4 Clearance Requirements.....	35
5.3 Installation Tools.....	37
5.4 Moving the Inverter.....	39
5.5 Installing Mounting-bracket.....	39
5.6 Installing the Inverter.....	41
<b>6 Electrical Connection.....</b>	<b>43</b>
6.1 Safety Instructions.....	43
6.2 Terminal Description.....	44
6.3 Electrical Connection Overview.....	47
6.4 Backup Wiring Diagram.....	49
6.5 External Protective Grounding Connection.....	53
6.5.1 External Protective Grounding Requirements.....	54
6.5.2 Connection Procedure.....	54
6.6 AC Cable Connection.....	56
6.6.1 AC Side Requirements.....	56
6.6.2 AC Cable Connection (MG5/6RL).....	56
6.6.2.1 Connecting the AC Cable.....	56
6.6.2.2 Backup Connection.....	58
6.6.2.3 Generator Connection.....	60
6.6.3 AC Cable Connection (MG8/10/12RL).....	62
6.7 DC Cable Connection.....	67
6.7.1 PV Input Configuration.....	68
6.7.2 Assembling the PV Connectors.....	70
6.7.3 Installing PV Connector.....	71
6.8 Battery Power Connection.....	72
6.8.1 Battery Connection Requirements.....	72
6.8.2 Battery Connection Procedure.....	72
6.8.2.1 Assembling the Battery Connectors (MG5/6RL).....	72
6.8.2.2 Assembling Battery Connector (MG8/10/12RL).....	75
6.9 Communication Connection.....	78
6.9.1 WiNet-S2 Connection.....	78

6.9.1.1 WLAN Communication.....	79
6.9.1.2 Ethernet Communication.....	79
6.9.2 COM2 Terminal Communication Connection.....	81
6.9.2.1 CT Connection.....	81
6.9.2.2 Smart Energy Meter Connection.....	83
6.9.2.3 DO Communication.....	84
6.9.2.4 Li-ion Battery Communication Connection.....	84
6.10 Temperature Sensor Connection.....	85
<b>7 Commissioning/Startup Procedure.....</b>	<b>88</b>
7.1 Inspection Before Commissioning.....	88
7.2 Commissioning Procedure.....	88
7.3 App Preparation.....	89
7.4 Creating a Plant.....	89
<b>8 LCD Screen Operation.....</b>	<b>90</b>
8.1 Initialization Settings.....	90
8.2 Home Screen Information.....	99
8.3 Settings.....	101
8.3.1 Battery Parameters.....	101
8.3.2 Multi-Function Port Parameters.....	103
8.3.3 Power Regulation Parameter.....	103
8.3.4 Genset Parameters.....	104
8.3.5 System Parameters.....	105
8.3.6 Off-grid Parameters.....	106
8.3.7 Operation Parameters.....	107
8.3.8 Multi-machine Parameters.....	114
<b>9 iSolarCloud App.....</b>	<b>116</b>
9.1 About iSolarCloud.....	116
9.2 Install iSolarCloud.....	117
9.3 User Roles.....	118
9.4 Device Commissioning.....	118
<b>10 System Decommissioning/Shutdown Procedure.....</b>	<b>119</b>
10.1 Decommissioning the Inverter.....	119
10.1.1 Disconnecting the Inverter.....	119
10.1.2 Dismantling the Inverter.....	119
10.1.3 Disposal of Inverter.....	120
10.2 Decommissioning the Battery.....	120
<b>11 Troubleshooting and Maintenance.....</b>	<b>121</b>
11.1 Troubleshooting.....	121
11.2 Maintenance.....	128

11.2.1 Maintenance Notices.....	128
11.2.2 Maintenance Notices.....	129
11.2.3 Routine Maintenance.....	130
<b>12 Appendix.....</b>	<b>131</b>
12.1 Technical Data.....	131
12.2 Quality Assurance.....	140
12.3 Contact Information.....	141

# 1 Safety Instructions

When installing, commissioning, operating, and maintaining the product, strictly observe the labels on the product and the safety requirements in the manual. Incorrect operation or work may cause:

- Injury or death to the operator or a third party.
- Damage to the product and other properties.

## WARNING

- **Do not perform any operation on the product (including but not limited to, handling, installing, powering on, or maintaining the product, performing electrical connection, and working at heights) in harsh weather conditions, such as thunder and lightning, rain, snow, and Level 6 or stronger winds. SUNGROW shall not be held liable for any damage to the device due to force majeure, such as earthquakes, floods, volcanic eruptions, mudslides, lightning strikes, fires, wars, armed conflicts, typhoons, hurricanes, tornadoes, and other extreme weathers.**
- **In case of fire, evacuate from the building or product area and call the fire alarm. Re-entry into the burning area is strictly prohibited under any circumstances.**

## NOTICE

- **Tighten the screws with the specified torque using tools when fastening the product and terminals. Otherwise, the product may be damaged. And the damage caused is not covered by the warranty.**
- **Learn how to use tools correctly before using them to avoid hurting people or damaging the device.**
- **Maintain the device with sufficient knowledge of this manual and use proper tools.**



- The safety instructions in this manual are only supplements and cannot cover all the precautions that should be followed. Perform operations considering actual onsite conditions.
- SUNGROW shall not be held liable for any damage caused by violation of general safety operation requirements, general safety standards, or any safety instruction in this manual.
- When installing, operating, and maintaining the product, comply with local laws and regulations. The safety precautions in this manual are only supplements to local laws and regulations.
- During the product transport, installation, wiring, maintenance, etc., the materials and tools prepared by users must meet the requirements of applicable local laws and regulations, safety standards, and other specifications. SUNGROW shall not be held liable for any damage to the product caused by the adoption of materials and tools that fail to meet the above-mentioned requirements.
- Operations on the product, including but not limited to, handling, installing, wiring, powering on, maintenance, and use of the product, must not be performed by unqualified personnel. SUNGROW shall not be held liable for any damage to the product resulting from operations done by unqualified personnel.
- Where the transport of the product is arranged by users, SUNGROW shall not be held liable for any damage to the product that is caused by users themselves or the third-party transport service providers designated by the users.
- SUNGROW shall not be held liable for any damage to the product caused by the negligence, intent, fault, improper operation, and other behaviors of users or third-party organizations.
- SUNGROW shall not be held liable for any damage to the product arising from reasons unrelated to SUNGROW.

## 1.1 Unpacking and Inspection

### WARNING

- **Check all safety signs, warning labels and nameplates on devices.**
- **The safety signs, warning labels and nameplates must be clearly visible and cannot be removed or covered before the device is decommissioned.**

**NOTICE**

After receiving the product, check whether the appearance and structural parts of the device are damaged, and check whether the packing list is consistent with the actual ordered product. If there are problems with the above inspection items, do not install the device and contact your distributor first. If the problem persists, contact SUNGROW in time.

## 1.2 Installation Safety

**⚠ DANGER**

- Make sure there is no electrical connection before installation.
- Before drilling, avoid the water and electricity wiring in the wall.

**⚠ CAUTION**

Improper installation may cause personal injury!

- If the product supports hoisting transport and is hoisted by hoisting tools, no one is allowed to stay under the product.
- When moving the product, be aware of the product weight and keep the balance to prevent it from tilting or falling.

**NOTICE**

Before operating the product, must check and ensure that tools to be used have been maintained regularly.

## 1.3 Electrical Connection Safety

**⚠ DANGER**

Before electrical connections, please make sure that the inverter is not damaged, otherwise it may cause danger!  
Before electrical connections, please make sure that the inverter switch and all switches connected to the inverter are set to "OFF", otherwise electric shock may occur!

**⚠ DANGER**

The PV string will generate lethal high voltage when exposed to sunlight.

- Operators must wear proper personal protective equipment during electrical connections.
- Must ensure that cables are voltage-free with a measuring instrument before touching DC cables.
- Respect all safety instructions listed in relevant documents about PV strings.

**⚠ DANGER**

Danger to life due to a high voltage inside the inverter!

- Be sure to use special insulation tools during cable connections.
- Note and observe the warning labels on the product, and perform operations strictly following the safety instructions.
- Respect all safety instructions listed in this manual and other pertinent documents.

**⚠ DANGER**

If the battery is short-circuited, the instantaneous current will be excessively high and a large amount of energy will be released, which may cause fire and personal injury.

Disconnect the battery from all voltage sources prior to performing any work on the battery.

Lethal voltages are present at the battery terminals and cables connecting to the inverter. Severe injuries or death may occur if the cables and terminals in the inverter are touched.

Observe all safety information provided by the battery manufacturer.

**⚠ WARNING**

Damage to the product caused by incorrect wiring is not covered by the warranty.

- Electrical connection must be performed by professionals.
- Please use measuring devices with an appropriate range. Overvoltage can damage the measuring device and cause personal injury.
- All cables used in the PV generation system must be firmly attached, properly insulated, and adequately dimensioned.
- Do not damage the ground conductor. Do not operate the product in the absence of a properly installed ground conductor. Otherwise, it may cause personal injury or product damage.

**⚠ WARNING**

Check the positive and negative polarity of the PV strings, and connect the PV connectors to corresponding terminals only after ensuring polarity correctness. During the installation and operation of the inverter, please ensure that the positive or negative poles of PV strings do not short-circuit to the ground. Otherwise, an AC or DC short-circuit may occur, resulting in equipment damage. The damage caused by this is not covered by the warranty.

The interfaces of the battery in the system must be compatible with the inverter. The entire battery voltage range must be completely within the permissible range of the inverter, and the battery voltage shall not exceed the maximum permissible DC input voltage of the inverter.

**NOTICE**

- Comply with the safety instructions related to PV strings and the regulations related to the local grid.
- Install the external protective grounding cable first when performing electrical connection and remove the external protective grounding cable last when removing the inverter.

## 1.4 Operation Safety

**⚠ DANGER**

When routing cables, ensure a distance of at least 30 mm between the cables and heat-generating components or areas to protect the insulation layer of cables from aging and damage.

When the product is working:

- Do not open the product enclosure.
- It is strictly forbidden to plug and unplug any connector on the inverter.
- Do not touch any wiring terminal of the inverter. Otherwise, electric shock may occur.
- Do not disassemble any parts of the inverter. Otherwise, electric shock may occur.
- It is strictly forbidden to touch any hot parts of the inverter (such as the heat sink). Otherwise, it may cause burns.
- Do not connect or remove any battery. Otherwise, electric shock may occur.
- Do not connect or remove any PV string or any PV module in a string. Otherwise, electric shock may occur.
- If the inverter is equipped with a DC switch, do not operate it. Otherwise, it may cause device damage or personal injury.

Do not take other actions, such as setting parameters or cutting off power, during the process of inverter firmware update, to avoid update failure.

## 1.5 Maintenance Safety

### DANGER

**Risk of inverter damage or personal injury due to incorrect service!**

- Before maintenance, disconnect the AC circuit breaker on the grid side and then the DC switch. If a fault that may cause personal injury or device damage is found before maintenance, disconnect the AC circuit breaker and wait until the night before operating the DC switch. Otherwise, a fire inside the product or an explosion may occur, causing personal injuries.
- After the inverter is powered off for 10 minutes, measure the voltage and current with professional instrument. Only when there is no voltage nor current can operators who wear protective equipment operate and maintain the inverter.
- Even if the inverter is shut down, it may still be hot and cause burns. Wear protective gloves before operating the inverter after it cools down.

### DANGER

**Touching the power grid or the contact points and terminals on the inverter connected to the power grid may lead to electric shock!**

- The power grid side may generate voltage. Always use a standard voltmeter to ensure that there is no voltage before touching.

### CAUTION

**To prevent misuse or accidents caused by unrelated personnel, post prominent warning signs or demarcate safety warning areas around the product.**

### NOTICE

**To avoid the risk of electric shock, do not perform any other maintenance operations beyond those described in this manual. If necessary, contact your distributor first. If the problem persists, contact SUNGROW. Otherwise, the losses caused is not covered by the warranty.**

**NOTICE**

- If the paint on the inverter enclosure falls or rusts, repair it in time. Otherwise, the inverter performance may be affected.
- Do not use cleaning agents to clean the inverter. Otherwise, the inverter may be damaged, and the loss caused is not covered by the warranty.
- As the inverter contains no parts that can be maintained, never open the enclosure of the inverter or replace any internal components without authorization. Otherwise, the loss caused is not covered by the warranty.
- Do not open the maintenance door in rainy or snowy weather. If it is inevitable, take proper protective measures to avoid the ingress of rainwater and snow into the maintenance compartment; otherwise, the product's operation may be affected.
- Before closing the maintenance door, check whether there is any object left inside the maintenance compartment, such as screws, tools, etc.
- It is recommended for users to use cable sheathing to protect the AC cable. If the cable sheathing is used, make sure it is positioned inside the maintenance compartment.

## 1.6 Disposal Safety

** WARNING**

Please scrap the product in accordance with relevant local regulations and standards to avoid property losses or casualties.

## 2 Product Description

### 2.1 System Introduction

The inverter is a transformerless single-phase hybrid inverter. As an integral component in the power system, the inverter is designed to convert the direct current power generated from the PV modules or batteries into grid-compatible AC current and feeds the AC current to the utility grid.

The single-phase hybrid inverters are applicable to both on-grid and off-grid PV systems. With the integrated Energy Management System (EMS), they can control and optimize the energy flow so as to increase the self-consumption of the system.

#### WARNING

- **The inverter must only be operated with PV strings with class II protection in accordance with IEC 61730, application class A. It is not allowed for the positive pole or the negative pole of the PV strings to be grounded. This can cause the inverter to be destroyed.**
- **Damages to the product due to a faulty or damaged PV installation are not covered by warranty.**
- **Any use other than the one described in this document is not permitted.**
- **During the installation and operation of the inverter, please ensure that the positive or negative polarities of PV strings and those of batteries do not short-circuit to the ground. Otherwise, an AC or DC short-circuit may occur, resulting in equipment damage. The damage caused by this is not covered by the warranty.**
- **Do not short-circuit the Backup port during operation. Otherwise, the inverter or power distribution system will be seriously damaged. The loss is not covered by the SUNGROW warranty.**

#### NOTICE

- **For the TT utility grid, the N line voltage to ground must be 30 V or less.**
- **The utility grid must be a TN system for the off-grid application.**
- **The system is not suitable for supplying life-sustaining medical devices. It cannot guarantee backup power in all circumstances.**
- **The inverter applies only to the scenarios described in this manual.**

## 2.2 Product Introduction

### Model Description

The model description is as follows (take MG5RL as an example):

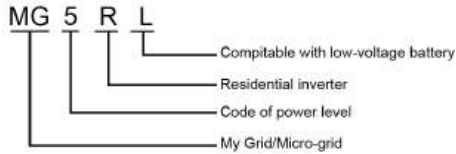

### Appearance

The following figure shows the appearance of the inverter. The image shown here is for reference only. The actual product received may differ (take MG5RL as an example).

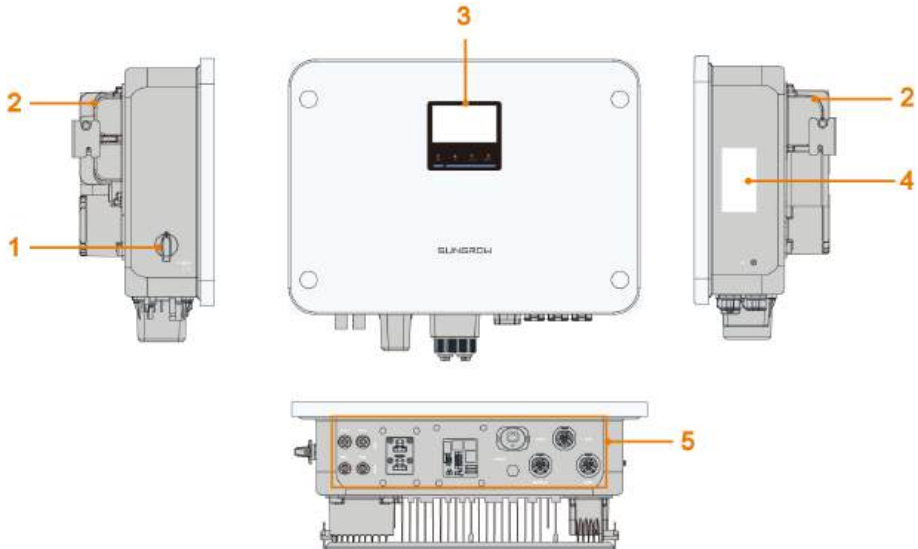

**Figure 2-1** Inverter Appearance

No	Name	Description
1	DC switch	To safely disconnect the DC circuit whenever necessary.
2	Hanger	To hang the inverter on the wall-mounting bracket.
3	LCD screen	The LCD screen indicates the running information and the current working state of the inverter, and battery SOC state. It also provides a human-machine interaction interface.

No	Name	Description
4	Nameplate	To clearly identify the product, including device model, S/N, important specifications, marks of certification institutions, information about <b>COM2</b> pin definition, etc.
5	Electrical connection area	PV terminals, battery terminals, AC terminals, and communication terminals.

### Dimensions

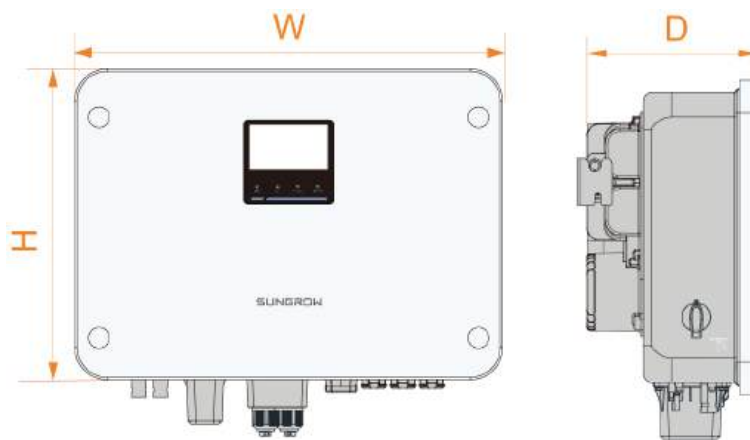

The following figure shows the dimensions of the inverter (take MG5RL as an example).











**Figure 2-2** Dimensions of the Inverter

Inverter Model	W (mm)	H (mm)	D (mm)
MG5/6RL	532	386	210
MG8/10/12RL	552	448	250

## 2.3 Symbols on the Product

Symbol	Explanation
	CE mark of conformity. EU/EEA Importer
	RCM mark of conformity.

Symbol	Explanation
	Do not dispose of the inverter together with household waste.
	The inverter does not have a transformer.
	Disconnect the inverter from all the external power sources before maintenance!
	Read the user manual before maintenance!
	Read the user manual before maintenance!
	Burn danger due to hot surface that may exceed 60°C.
	Danger to life due to high voltages! Only qualified personnel can open and service the inverter.
	Do not touch live parts for 10 minutes after disconnection from the power sources.
	Additional grounding point.

Users may also put other warning signs as per the requirements of the local standards or installation specifications.

## 2.4 LCD Screen

Located on the front of the inverter, the LCD screen displays information along with status indicators.

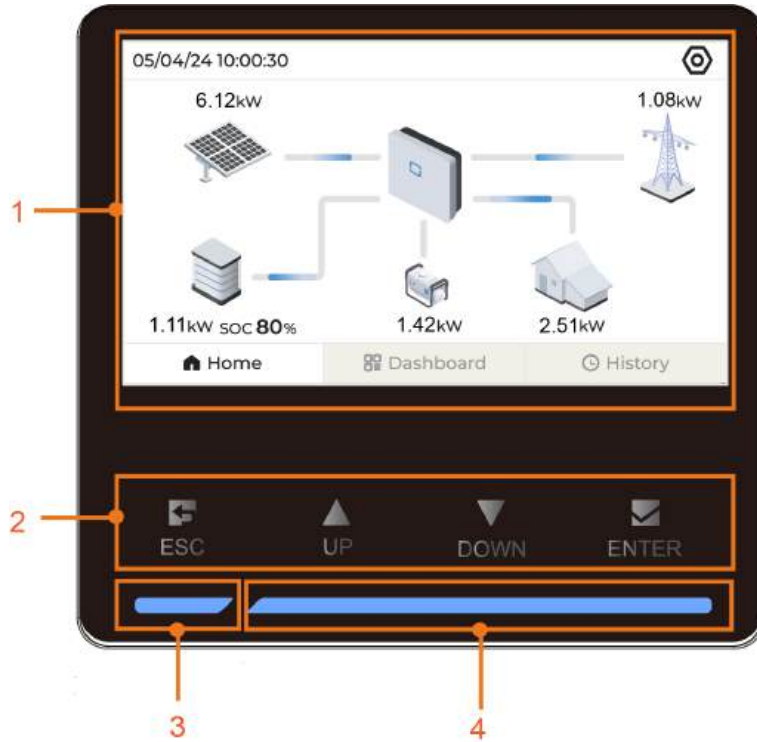







Figure 2-3 LCD Screen

Table 2-1 LCD Screen Description





No.	Name	Description
1	LCD touchscreen	Human-machine interface for viewing operational data and parameter configuration.
2	Buttons	<ul style="list-style-type: none"> <li>• ESC: Return to previous menu.</li> <li>• UP: Previous page</li> <li>• DOWN: Next page</li> <li>• ENTER: Confirm parameter settings via the keypad.</li> </ul> <div style="border: 1px solid gray; padding: 5px; margin-top: 10px;"> <p> To restore the factory default password, press and hold both ESC and ENTER for 5 seconds until the operation status indicator flashes rapidly 4 times.</p> </div>
3	Operation Status Indicator	Inverter operation status

No.	Name	Description
4	Battery SOC Indicator	Battery SOC

**Table 2-2** Operation Status Indicator Description

LED indicator	LED state	Definition
	ON	The inverter is running in the on/off-grid mode.
	Twinkling (Period: 2s)	The inverter is at standby or startup state (without on/off-grid operation). The inverter is recovering from a fault.
	ON	A system fault has occurred.
	OFF	Both the AC and DC sides are powered down.

**Table 2-3** Battery SOC Indicator

Battery SOC Indicator	SOC
	0 < SOC ≤ 20%
	20% < SOC ≤ 40%
	40% < SOC ≤ 60%
	60% < SOC ≤ 80%
	SOC > 80%

 The direction of the LED bar indicates the battery's charge and discharge status:

- Charging: The LED bar flows dynamically from 0% SOC to 100% SOC.
- Discharging: The LED bar flows dynamically from 100% SOC to 0% SOC.

 The figures shown are for illustration purposes only. The actual product may vary.

## 2.5 DC Switch

The DC switch is used to disconnect or connect the PV-DC circuit.

The inverter operates automatically when input and output requirements are met. Rotate the DC switch to the “OFF” position to stop the inverter when a fault occurs. When you need to stop the inverter normally please first turn off AC and shut down the hybrid inverter via App.



Turn the DC switch to the “ON” position before restarting the inverter.

## 2.6 PV Energy Storage System (PV ESS)

### NOTICE

When designing the system, ensure that the operating ranges of all devices that are connected to the inverter meet the requirements of the inverter.

### 2.6.1 PV Energy Storage System (PV ESS)

The following figure shows inverter application in a PV energy storage system.

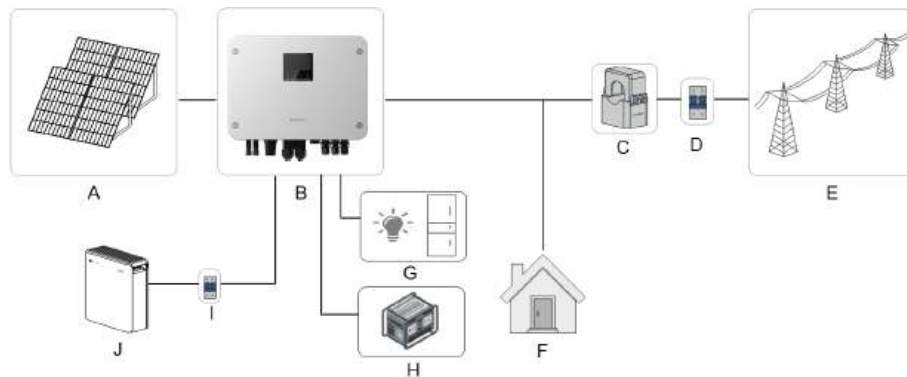
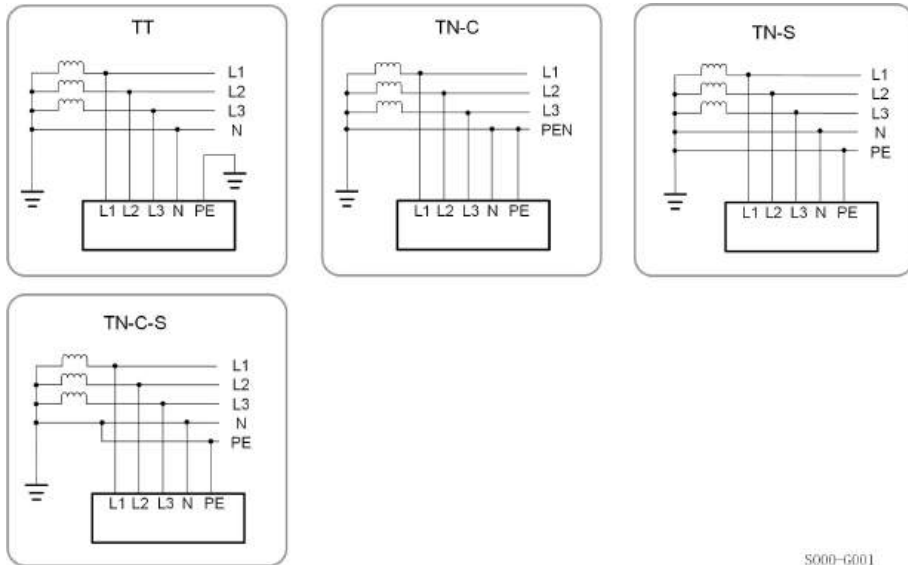

Figure 2-4 PV Energy Storage System

Item	Description	Note
A	PV strings	Compatible with monocrystalline silicon, polycrystalline silicon, and thin-film modules without grounding.
B	Inverter	MG5/6/8/10/12RL
C	CT	Used to measure current at the grid connection point.
D	AC circuit breaker	AC circuit breaker

Item	Description	Note
E	Utility grid	TT, TN-C, TN-S, TN-C-S.
F	Normal Loads	Common loads, which will be lack of power when grid is blackout.
G	Backup loads	Loads, connected to inverter backup port, which need uninterrupted power supply.
H	Generator/ Load	Only the generator or the load (not both) can be connected.
I	DC Breaker	DC Breaker
J	Battery	Li-ion battery or lead-acid battery

The following figure shows the common grid configurations.



S000-G001

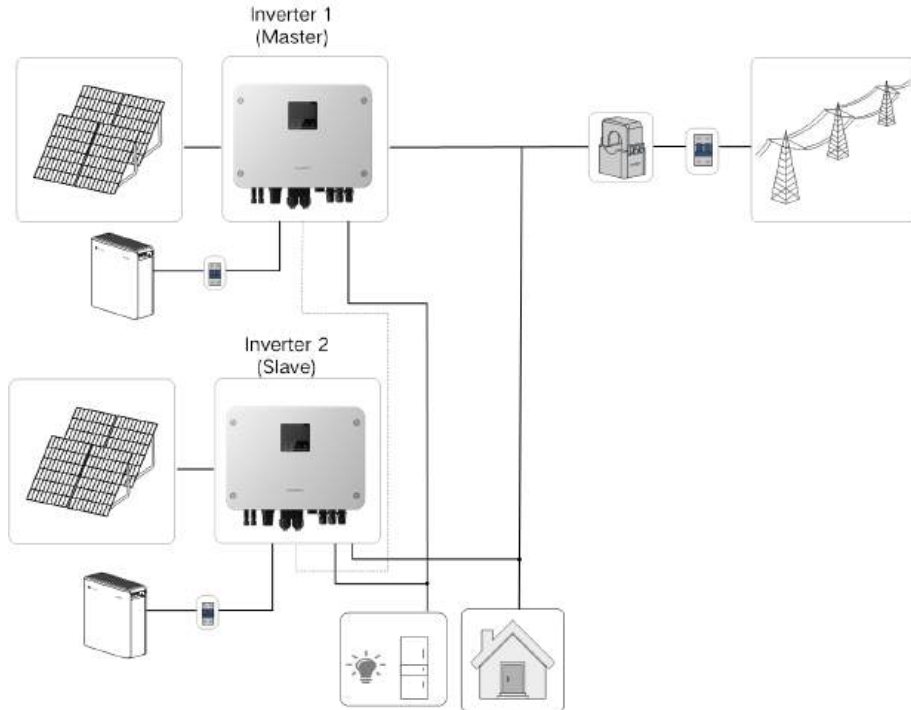

**Figure 2-5** Two Hybrids Parallel System



For two hybrids in parallel, each with its own independent battery connection, only MG5/6RL are supported.  
If the number of inverters in parallel exceeds 2, please contact SUNGROW for more information.

### Parallel Battery Connection System

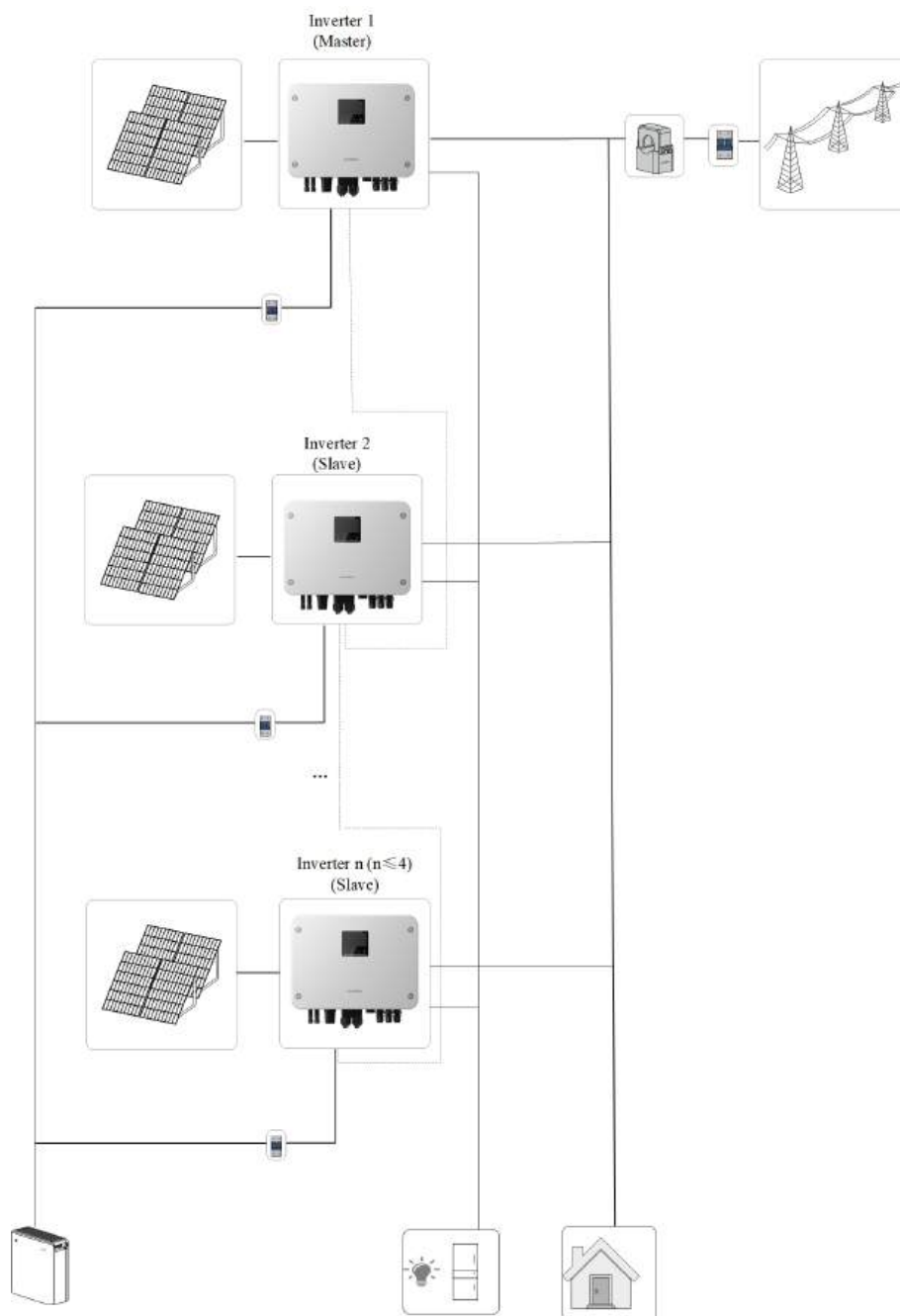

Figure 2-6 Parallel Battery Connection System

This system diagram is for illustrative purposes only and does not include all connection details. Please ensure all system wiring is installed in compliance with local installation standards and regulations.



- The system supports parallel connection of up to four inverters. For more than 4 inverters, please contact Sungrow.
- The battery terminals on the inverter side are connected in parallel and linked to the battery via a busbar (to be prepared by the user).

The version requirements for each device are as follows:

Battery Type	Inverter Model	Firmware Version Requirement
Third-party li-ion battery	MG5/6RL	<ul style="list-style-type: none"> <li>• Inverter: ≥BARITE-H_B001.V001.P06</li> <li>• WiNet-S2: ≥WINET-SV300.001.03.P022</li> <li>• iSolarCloud:               <ul style="list-style-type: none"> <li>- ≥V2.1.6.20250828 for iOS</li> <li>- ≥V2.1.6.20250828 for Android</li> </ul> </li> </ul>
	MG8/10RL	<ul style="list-style-type: none"> <li>• Inverter: ≥BARITE-H_B001.V001.P08</li> <li>• WiNet-S2: ≥WINET-SV300.001.03.P026B002</li> <li>• iSolarCloud:               <ul style="list-style-type: none"> <li>- ≥V2.1.6.20251220 for iOS</li> <li>- ≥V2.1.6.20251223 for Android</li> </ul> </li> </ul>
	MG12RL	<ul style="list-style-type: none"> <li>• Inverter: ≥BARITE-H_B001.V001.P11-20260421</li> <li>• WiNet-S2: ≥WINET-SV300.001.03.P030</li> <li>• iSolarCloud:               <ul style="list-style-type: none"> <li>- ≥V2.1.6.20260421 for iOS</li> <li>- ≥V2.1.6.20260428 for Android</li> </ul> </li> </ul>
MBL050/120/160	MG5/6/8/10/12RL	<ul style="list-style-type: none"> <li>• Inverter: ≥BARITE-H_B001.V001.P11</li> <li>• WiNet-S2: ≥WINET-SV300.001.03.P030</li> <li>• iSolarCloud:               <ul style="list-style-type: none"> <li>- ≥V2.1.6.20260421 for iOS</li> <li>- ≥V2.1.6.20260428 for Android</li> </ul> </li> </ul>
MGL060, lead-acid battery	MG5/6/8/10RL	<ul style="list-style-type: none"> <li>• Inverter: ≥BARITE-H_B001.V001.P09</li> <li>• MGL060: ≥SBLBCU-S_B000.V000.P004</li> </ul>

Battery Type	Inverter Model	Firmware Version Requirement
		<ul style="list-style-type: none"> <li>• WiNet-S2: ≥WINET-SV300.001.03.P029B001</li> <li>• iSolarCloud:               <ul style="list-style-type: none"> <li>- ≥V2.1.6.20260319 for iOS</li> <li>- ≥V2.1.6.20260324 for Android</li> </ul> </li> </ul>

Function/Scenario	Firmware Version Requirement
Staged load connection to GEN port	<ul style="list-style-type: none"> <li>• Inverter: ≥BARITE-H_B001.V001.P09</li> <li>• MGL060: ≥SBLBCU-S_B000.V000.P004</li> <li>• WiNet-S2: ≥WINET-SV300.001.03.P029B001</li> <li>• iSolarCloud App:               <ul style="list-style-type: none"> <li>- ≥V2.1.6.202600319 for iOS</li> <li>- ≥V2.1.6.20260324 for Android</li> </ul> </li> </ul>
On-grid port retrofit	<ul style="list-style-type: none"> <li>• Inverter: ≥BARITE-H_B001.V001.P11</li> <li>• WiNet-S2: ≥WINET-SV300.001.03.P030</li> </ul>
Minimum output voltage during off-grid operation settable	<ul style="list-style-type: none"> <li>• iSolarCloud App:               <ul style="list-style-type: none"> <li>- ≥V2.1.6.20260421 for iOS</li> <li>- ≥V2.1.6.20260428 for Android</li> </ul> </li> </ul>



For more version information, please contact Sungrow.

## 2.6.2 Declaration For Backup Function

### **⚠ DANGER**

**This product is not suitable for supplying power to life-sustaining medical devices since power outages may result in danger to life.**

The following statement involves SUNGROW general policies about the hybrid inverters described in this document.

1. For hybrid inverters, the electrical installation typically includes connection of the inverter to both PV modules and batteries. If there is no available power from batteries or PV modules in backup mode, the backup power supply will be automatically terminated. SUNGROW shall hold no liability for any consequences arising from failing to observe this instruction.
2. Normally, the backup switching time is less than 4 ms . However, some external factors or local regulations may cause the system to fail on backup mode. Therefore, the users must be aware of conditions and follow the instructions as below:
  - Do not connect loads that are dependent on a stable energy supply for a reliable operation.

- Do not connect the loads whose total capacity is greater than the maximum backup capacity.
- Due to the condition of the battery itself, battery current might be limited by some factors, including but not limited to the temperature and weather.

### Declaration For Backup Overload Protection

The inverter will restart in case of Overload Protection. The time required for restarting will increase (10 min at most) if Overload Protection repeats. Try to reduce backup load power within maximum limitation or remove the loads which may cause very high start-up current surges.

## 2.7 Retrofitting the Existing PV System

The hybrid inverter is compatible with any single-phase PV grid-connected inverters. An existing PV system can be retrofitted to be a PV ESS with the addition of the hybrid inverter.

The power generation from the existing PV inverter will be firstly provided to the loads and then charge the battery. With the energy management function of the hybrid inverter, the self-consumption of the new system will be greatly improved.

### Retrofit the Existing PV Inverter(s) to the Hybrid Inverter On-grid Port

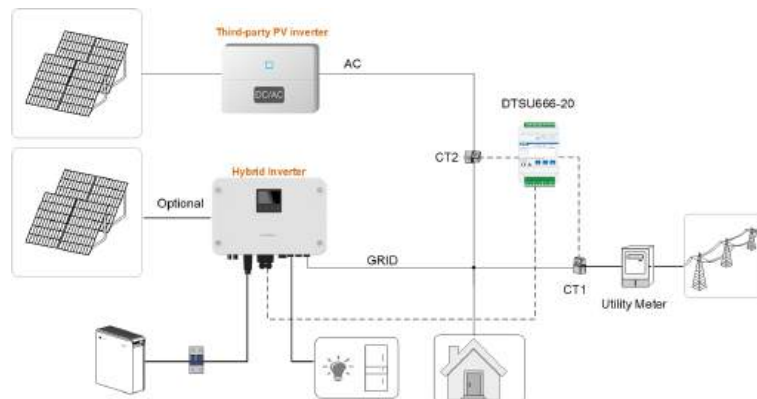

**Figure 2-7** Retrofit the Existing PV Inverter(s) to the Hybrid Inverter On-grid Port

The AC terminal of the PV inverter and the GRID terminal of the hybrid inverter are combined to the grid. Please refer to the diagram below for specific DTSU666-20 wiring.

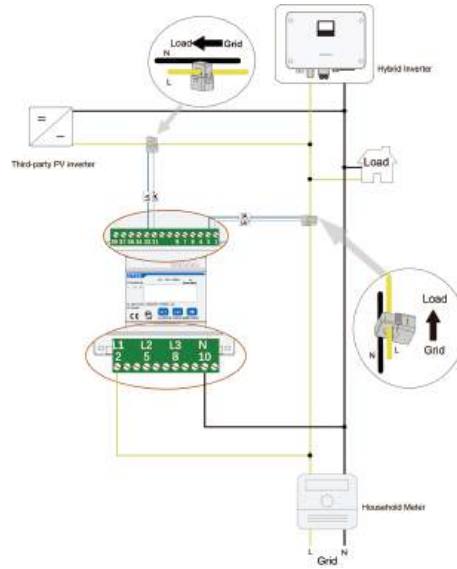

- In zero-export scenario, the hybrid inverter can only ensure no power exported to grid itself but does not ensure zero-export for the PV inverter. Please contact the PV inverter manufacturer for its zero-export solution.
- PV modules for hybrid inverter are optional.
- If the system adopts third-party inverters, the electric meter requires 2 CTs for monitoring, with CT1 connected to the grid port and CT2 connected to the AC port of the third-party inverters. If SUNGROW inverters are adopted, only 1 CT is required, and the CT shall be connected to the grid port.



## 3 Function Description

### 3.1 Safety Function

#### 3.1.1 Protection

Several protective functions are integrated in the inverter, including short circuit protection, grounding insulation resistance surveillance, residual current protection, anti-islanding protection, DC overvoltage / over-current protection, etc.

#### 3.1.2 Earth Fault Alarm

The device gives an alarm if there is a grounding fault. If the AC side is poorly grounded or not grounded, the LED indicator turns red.

### 3.2 Energy Conversion and Management

The inverter converts the DC power from the PV array or the battery to the AC power, in conformity with the grid requirements. It also transmits the DC power from the PV panel to the battery.

With the bidirectional converter integrated inside, the inverter can charge or discharge the battery.

Multiple string MPP trackers are used to maximize the power from PV strings with different orientations, tilts, or module structures.

#### 3.2.1 Power Derating

Power derating is a way to protect the inverter from overload or potential faults. In addition, the derating function can also be activated following the requirements of the utility grid.

- over-temperature (including ambient temperature and module temperature)
- high input voltage
- grid under-voltage
- grid over-voltage
- grid over-frequency
- power factor (when values out of the rated values)

#### 3.2.2 Regular Operational Voltage Range

The inverters can operate within the allowable voltage range for at least the specified observation time. The setting of the conditions depends on whether the connection is due to a normal operational start-up or an automatic reconnection after disconnection from grid.

When the voltage level is out of the operational and protection levels, the inverter will disconnect within the specified time from the grid. If a disturbance lasts longer than the required protection time, the inverter can reconnect to the grid once the voltage level goes back to normal levels after the disturbance.

### 3.2.3 Regular Operational Frequency Range

The inverter can operate within its frequency range for at least the specified observation time. The setting of conditions depends on whether the connection is due to a normal operational start-up or an automatic reconnection after disconnection from grid.

When the frequency level is outside the operational and protection levels, the inverter will disconnect from the grid. If a disturbance lasts longer than the required protection time, the inverter can reconnect to the grid once the frequency level goes back to normal levels after the disturbance.

### 3.2.4 Reactive Power Regulation

The inverter is capable of operating in reactive power regulation modes for the purpose of providing support to the grid. The reactive power regulation mode can be set via the iSolarCloud App.

### 3.2.5 Load Control

The inverter has an integrated multiple-function dry-contact (DO relay), which can be used for load control via a contactor.

- **Scheduled Mode:** Set the starting time and end time. The DO function will be enabled during the time interval.
- **Switch Mode:** The DO function can be enabled or disabled.
- **Intelligent Mode:** Activate load when power reaches Load Rated Power value within set time windows.
- **Disable Mode:** Disable DO port intelligent load control.

## 3.3 Communication and Configuration

The inverter possesses various ports for device and system monitoring, including RS485, Ethernet, WLAN, and CAN; various parameters can be configured for optimal operation. The inverter information is accessible through the LCD screen or iSolarCloud App.

## 3.4 Import Power Limit Function

Import power means the total power purchased from grid, which includes power to charge the battery from grid via inverter, power consumed by local loads and loads connected to inverter backup port from grid. Following local regulations, calculate the maximum system tolerable power based on the wire and circuit breaker that required by the selected model, and the value can be set as the **Purchase energy with limited power**.

### 3.5 PID Zero

The PID Zero function is applicable for both PV and DC-coupled PV plus storage systems. It can suppress PID during the day and intelligently repair PV panels damage caused by PID at night, by relieving or alleviating PV array voltage bias to PV-.

The traditional inverter needs boost circuit to extend the efficient generation time during the day, and break the symmetry of the PV array to the ground voltage, making it closer to the negative electrode. In addition, if the traditional inverter runs at night, the PV array to ground voltage is always limited to the lowest voltage point of the system, which increases the risk of PID.

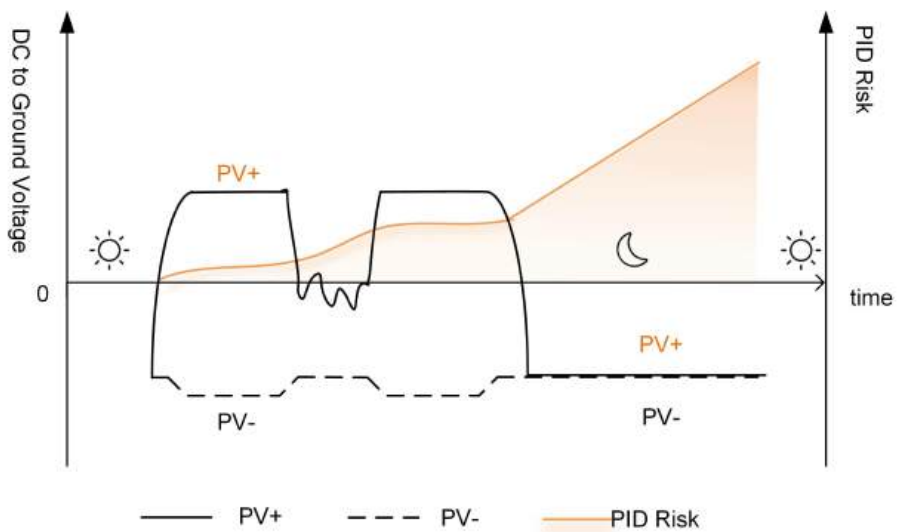

**Figure 3-1** PID Risk of Traditional Inverters

The following figure is the PID risk of the inverter equipped with PID Zero, it prevents the PV array voltage from approaching PV-, reduces the risk of PID during daily operation and repairs PV panels caused by PID at night. Details can be found in the *PID Zero White Paper*, which can be obtained on [www.sungrowpower.com](http://www.sungrowpower.com) or from your distributor.

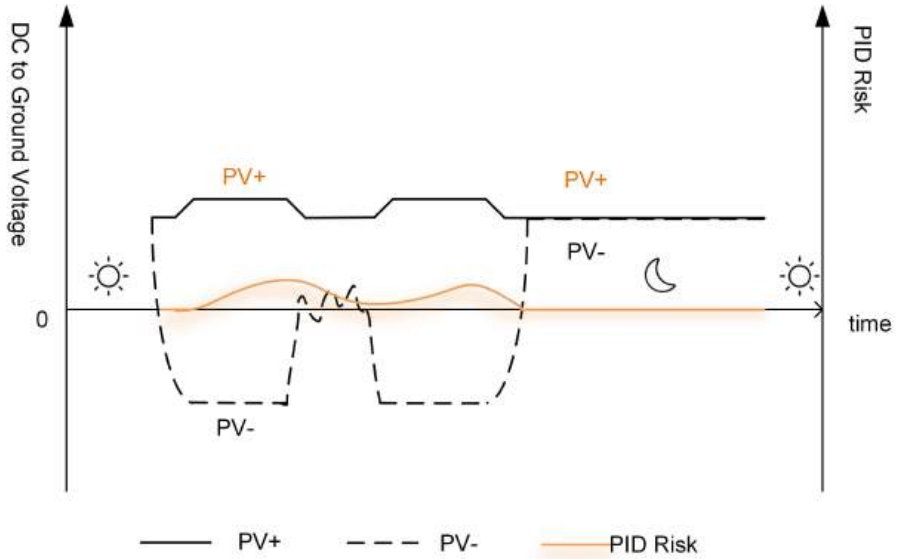

Figure 3-2 PID Risk of Inverters Equipped with PID Zero

**⚠ DANGER**  
 Keep the DC switch "ON" in the PID Zero process. During the process, there is voltage hazard between inverter / PV panels live conductors and ground. Do not touch any of them.

### 3.6 Battery Management

Batteries are compatible with the PV ESS, further battery models will be made compatible in the future.

The currently supported battery brands and models are shown in the following table.

Brand	Model
SUNGROW	MGL060*
	MBL050/120/160
Third-party	Li-ion battery
	Lead-acid battery



- \*MG8/10RL multi-unit paralleling system does not currently support MGL060. MG12RL does not currently support MGL060, lead-acid battery.
- The table is continually updated. If the battery model is not in the table, consult SUNGROW if it is supported.
- Installation of lead-acid batteries requires a PT100 temperature sensor (user-supplied).

For li-ion battery, to maximize the battery life, the inverter will perform battery charge, discharge, and battery maintenance based on the battery status communicated by the BMS.

For lead-acid battery, during initial installation, set the Battery Parameters by manually entering the value calculated as (battery Ah per cluster) × (number of battery cluster).



The Ah of lead-acid batteries connected in parallel within a cluster must be consistent.

#### NOTICE

- **The recommended parameters listed in this section may be updated or revised due to product development. Please refer to the manual supplied by the battery manufacturer for the latest information.**
- **If a third-party battery product is to be used, please consult the manufacturer for the battery's charge and discharge performance. SUNGROW cannot guarantee that the use of a third-party battery product would allow the optimal performance of the hybrid inverter.**

## 4 Unpacking and Storage

### 4.1 Unpacking and Inspection

The product is thoroughly tested and strictly inspected before delivery. Nonetheless, damage may still occur during shipping. For this reason, please conduct a thorough inspection after receiving the product.

- Check the packing case for any visible damage.
- Check the scope of delivery for completeness according to the packing list.
- Check the inner contents for damage after unpacking.

Contact SUNGROW or the transport company in case of any damage or incompleteness, and provide photos to facilitate services.

Do not dispose of the original packing case. It is recommended to store the device in the original packing case when the product is decommissioned.

#### NOTICE

- **After receiving the product, check whether the appearance and structural parts of the device are damaged, and check whether the packing list is consistent with the actual ordered product. If there are problems with the above inspection items, do not install the device and contact your distributor first. If the problem persists, contact SUNGROW in time.**
- **If any tool is used for unpacking, be careful not to damage the product.**

## 4.2 Scope of Delivery



Figure 4-1 Scope of delivery(MG5/6RL)

Item	Name	Quantity
A	Inverter	1
B	Wall-mounting bracket	1
C	Battery connector	1
D	AC connector set	3
E	Expansion plug set	3
F	M5×12 screw set	2
G	M4×16 screw set	4
H	Current transformer(CT)	1
I	DO plug-in connector	1

Item	Name	Quantity
J	Signal plug-in connector	1
K	Wire ferrule*	9
L	Wire ferrule (DIN end)	12
M	PV connector set	2
N	Crimp contact set	2
O	Removal tool	1
P	Desiccant	1
Q	WiNet-S2	1
R	Documents	1



Figure 4-2 Scope of delivery(MG8/10/12RL)

Item	Name	Quantity
A	Inverter	1
B	Wall-mounting bracket	1
C	Battery connector	1
D	AC connector set	1
E	Expansion plug set	3
F	M5×12 screw set	2
G	M4×16 screw set	2
H	Current transformer(CT)	1
I	DO plug-in connector	1
J	Signal plug-in connector	1
K	OT terminal	9
L	Wire ferrule (DIN end)	12
M	PV connector set	3
N	Crimp contact set	3
O	M5×16 screw set	4
P	Desiccant	1
Q	WiNet-S2	1
R	Documents	1



The images shown here are for reference. The actual product and quantity are based on delivery.

### 4.3 Inverter Storage

Proper storage is required if the inverter is not installed immediately.

- Store the inverter in the original packing case with the desiccant inside.
- The storage temperature must be always between -30°C and +70°C, and the storage relative humidity must be always between 0 and 95 %, non-condensing.
- In case of stacking storage, the number of stacking layers should never exceed the limit marked on the outer side of the packing case.

- The packing case should be upright.
- If the inverter needs to be transported again, pack it strictly before loading and transporting it.
- Do not store the inverter in places susceptible to direct sunlight, rain, and strong electric field.
- Do not place the inverter in places with items that may affect or damage the inverter.
- Store the inverter in a clean and dry place to prevent dust and water vapor from eroding.
- Do not store the inverter in places with corrosive substances or susceptible to rodents and insects.
- Carry out periodic inspections. Inspection shall be conducted at least once every six months. If any insect or rodent bites are found, replace the packaging materials in time.
- If the inverter has been stored for one year or longer, or has been mounted but remains non-operational for more than three months, it must be inspected and tested by qualified personnel before being put into operation.

**NOTICE**

**Please store the inverter according to the storage requirements. Product damage caused by failure to meet the storage requirements is not covered by the warranty.**

## 5 Mechanical Mounting

### WARNING

Respect all local standards and requirements during mechanical installation.

### 5.1 Safety During Mounting

#### DANGER

Make sure there is no electrical connection before installation.  
Before drilling, avoid the water and electricity wiring in the wall.

#### WARNING

For specific requirements for the installation environment, see [5.2.1 Installation Environment Requirements](#). In case the environment where the product is installed does not meet the requirements, SUNGROW shall not be held liable for any property damage arising therefrom.

#### CAUTION

Improper handling may cause personal injury!

- When moving the product, be aware of its weight and keep the balance to prevent it from tilting or falling.
- Wear proper protective equipment before performing operations on the product.
- The bottom terminals and interfaces of the product cannot directly contact the ground or other supports. The product cannot be directly placed on the ground.

#### NOTICE

During installation, ensure that no device in the system causes it hard for the DC switch and the AC circuit breaker to act or hinders maintenance personnel from operating.

If drilling is required during installation:

- Wear goggles and protective gloves when drilling holes.
- Make sure to avoid the water and electricity wiring in the wall before drilling.
- Protect the product from shavings and dust.

## 5.2 Location Requirements

To a large extent, a proper installation location ensures safe operation, service life, and performance of the inverter.

- The inverter with protection rating IP65 can be installed both indoors and outdoors.
- The inverter should be installed at a height that allows easy viewing of the LED screen, as well as easy electrical connection, operation and maintenance.

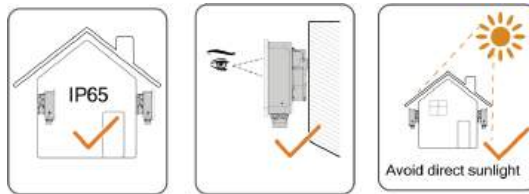

### 5.2.1 Installation Environment Requirements

- If the inverter is installed in a place with lush vegetation, weed on a regular basis. In addition, the ground beneath the inverter needs to undergo certain treatment, such as laying cement or gravel, etc. (an area of 3 m × 2.5 m is recommended).
- Do not install the inverter in an environment with flammables, explosives, or smoke.
- Do not install the inverter in places prone to water leak, e.g., under the air-conditioner vent, the air vent, or the cable outlet window of the machine room, so as to prevent device damage or short circuit caused by intrusion of water.
- Do not install the inverter in a place with corrosives such as corrosive gas and organic solvent, etc.
- When the inverter is running, its surface may carry high voltages or get very hot. Do not touch it; otherwise, it may lead to burns or electric shocks.
- Do not install the inverter in a place that can be easily reached.
- The installation site must have solid ground, free of rubber-like soils (which cannot be effectively compacted) or weak soils, and should not be prone to subsidence. Also, avoid low-lying areas where water or snow may accumulate. Ensure the site is located above the highest recorded water level in the area.
- Do not install the inverter in a position that could be flooded.
- To prevent vegetation or water on the ground from impacting inverter operation, if the space above meets the designated requirements, elevate the inverter to an appropriate height.
- Good heat dissipation is very important to the inverter. Please install the inverter in a ventilated environment.
- Please consult SUNGROW before installing inverters outdoors in areas prone to salt damage, which are mainly coastal areas within 500 meters of the coast. The sedimentation amount of salt spray is correlated to the characteristics of the seawater, sea winds, precipitation, air humidity, topography, and forest coverage in the adjacent sea areas, and there are substantial differences between different coastal areas.

- To ensure device safety and service life, avoid using this product in highly polluted environments containing substances such as sulfur or halogens.
- The inverter is strictly prohibited from being installed in environments with vibration or strong electromagnetic fields (including strong common-mode interference). A strong magnetic field environment refers to one where the magnetic field strength exceeds 30 A/m. The aforementioned environments may cause the product to malfunction.
- In dusty environments such as places full of dust, smoke, or floc, particles may cling to the device's air outlet or heat sink, thus impacting its heat dissipation performance or even getting it damaged. Therefore, do not install the inverter in dusty environments. If the inverter has to be installed in such environments, please clean its fans and heat sink on a regular basis to ensure a good heat dissipation performance.
- The average temperature approximately 1 m around the inverter should be taken as its ambient operating temperature. The temperature and humidity should meet the requirements below:

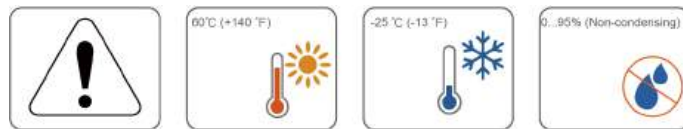

### 5.2.2 Carrier Requirements

The mounting structure where the inverter is installed must comply with local/national standards and guidelines. Ensure that the installation surface is solid enough to bear four times the weight of the inverter and is suitable for the dimensions of the inverter (e.g. cement walls, plasterboard walls, etc.).

Do not install the inverter on a carrier that may vibrate in resonance, so as to avoid making bigger noise.

Installation on combustible building materials is strictly prohibited. Suitable mounting surfaces include:

Non-combustible wall surfaces: Concrete, fire-resistant gypsum board, brick wall, etc. Non-combustible roof structures: Color-Coated corrugated steel roofing sheets, precast concrete slabs, fiber-reinforced cement boards, etc.

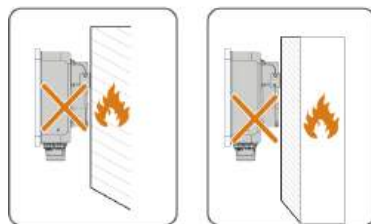

### 5.2.3 Angle Requirements

Install the inverter vertically. Never install the inverter horizontally, or at forward/backward tilted, or upside down.

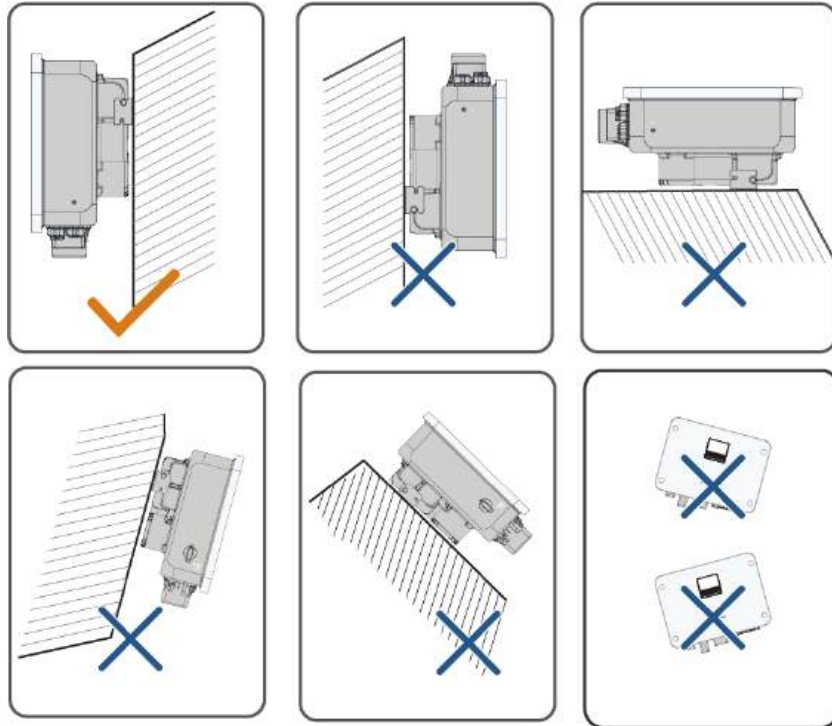

### 5.2.4 Clearance Requirements

Reserve enough clearance around the inverter to ensure sufficient space for heat dissipation.

- MG5/6RL:



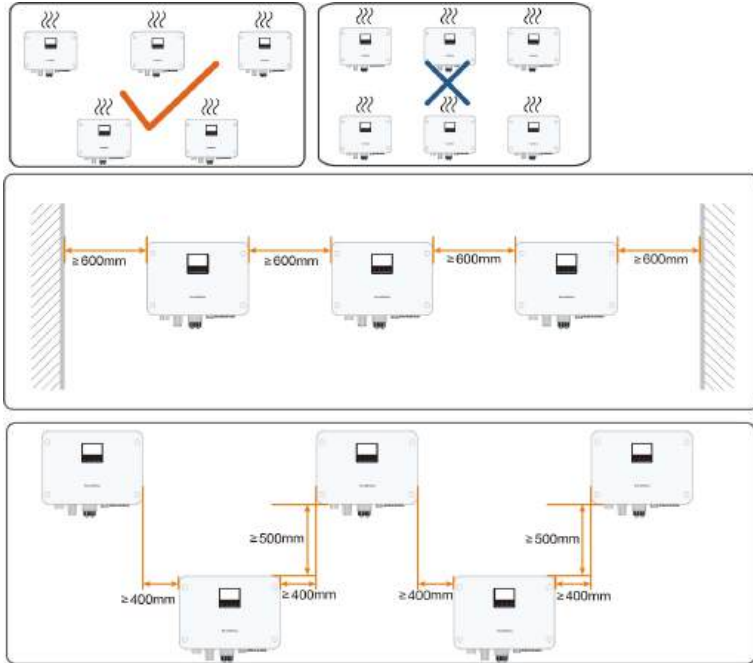

- MG8/10/12RL:

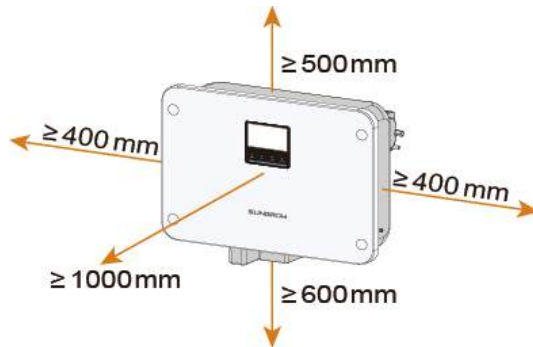

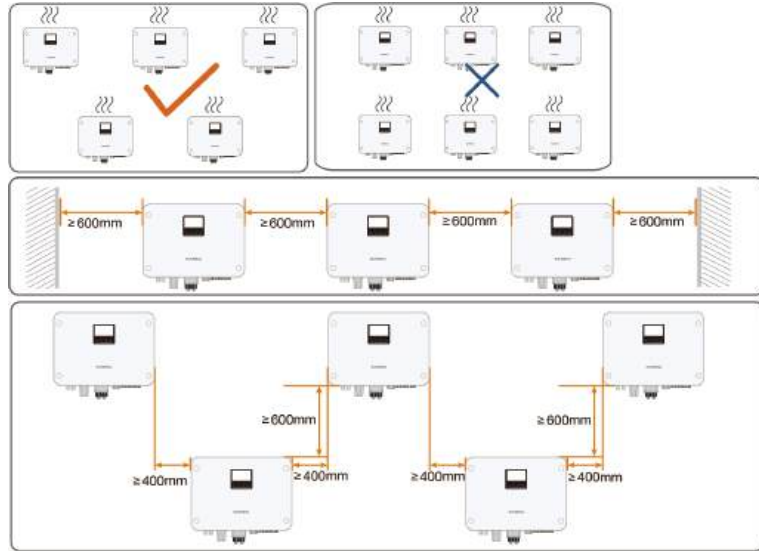

### 5.3 Installation Tools

Installation tools include but are not limited to the following recommended ones. If necessary, use other auxiliary tools on site.



Goggles

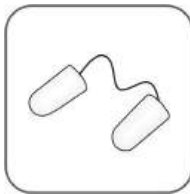

Earplugs

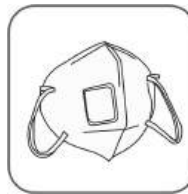

Dust mask



Safety gloves



Safety shoes



Utility knife



Slotted screwdriver\*\*



Phillips screwdriver (PH2)\*



Hammer drill  
( $\phi 10$ )



Marker



Vacuum cleaner



Rubber mallet



Anti-static wrist strap



Tube Terminal Crimping tool



Wire stripper



Hydraulic pliers



Heat gun



Crimping tool  
4–6mm<sup>2</sup>



Wrench for MC4



Multimeter  
 $\geq 1000V_{DC}$



Adjustable wrench



RJ45 crimping tool



Allen wrench



Socket wrench\*\*



Level                      Electric  
                                  screwdriver



A magnetic screwdriver with a shaft length of at least 200 mm is recommended. Magnetic tools are recommended.

## 5.4 Moving the Inverter

Before installation, remove the inverter from the packing case and move it to the installation site. Follow the instructions below as you move the inverter:

- Always be aware of the weight of the inverter.
- Lift the inverter using the handles positioned on both sides of the inverter.
- Move the inverter by one or two people or by using a proper transport tool.
- Do not release the equipment unless it has been firmly secured.

### CAUTION

**Improper handling may cause personal injury!**

- **Arrange an appropriate number of personnel to carry the inverter according to its weight, and installation personnel should wear protective equipment such as anti-impact shoes and gloves.**
- **Attention must be paid to the center of gravity of the inverter to avoid tilting during handling.**
- **Placing the inverter directly on a hard ground may cause damage to its metal enclosure. Protective materials such as sponge pad or foam cushion should be placed underneath the inverter.**
- **Move the inverter by holding the handles on it. Do not move the inverter by holding the terminals.**

## 5.5 Installing Mounting-bracket

The inverter can be installed on a bracket, a wall, and a pole by means of mounting-bracket.

Dimensions of the assembled mounting-bracket are as follows.

- MG5/6RL:

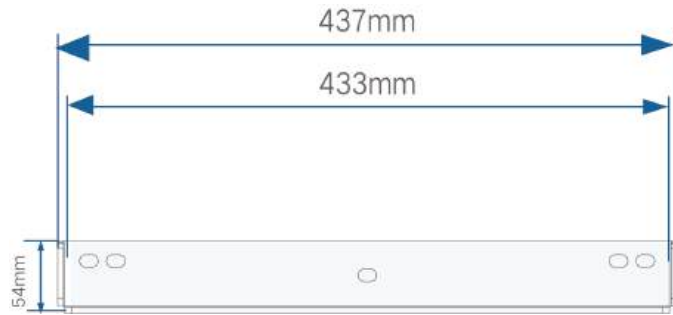

- MG8/10/12RL:

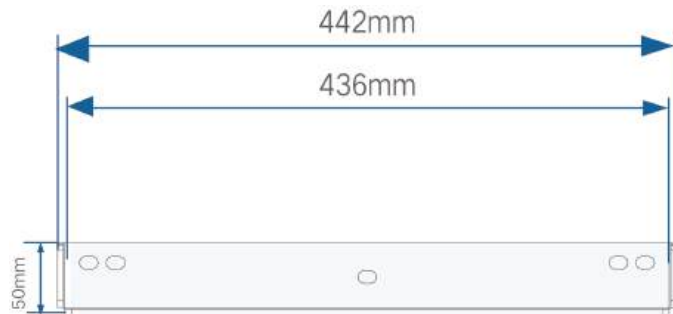

**Figure 5-1** Dimensions of Mounting-bracket

Reserve enough space when installing the mounting-bracket to meet the installation space requirements of the inverter.

- MG5/6RL:

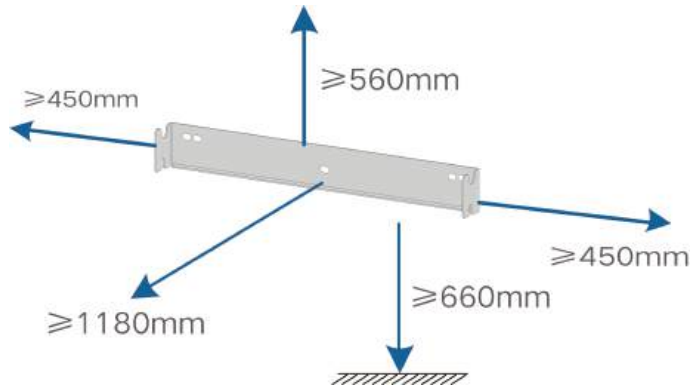

- MG8/10/12RL:

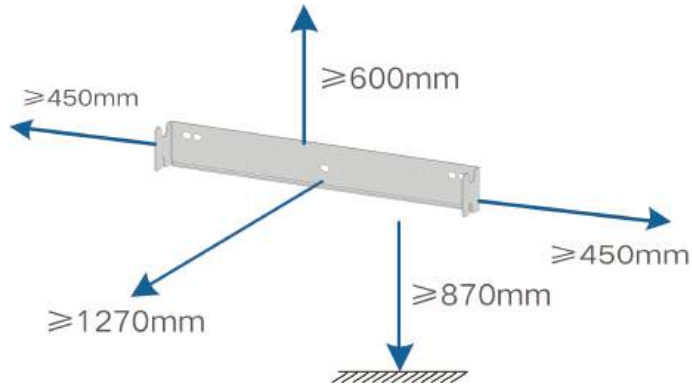

## 5.6 Installing the Inverter

Inverter is installed on the wall by means of wall-mounting bracket and the expansion plug sets.

The expansion plug set shown below is recommended for the installation.



(1) Self-tapping screw M6

(2) Expansion tube

(3) Fender washer

(4) Spring washer



The image shown here is for reference only. The actual product received may differ. The installation steps are provided using MG5/6RL as an example.

**Step 1** Place the wall-mounting bracket to a proper position on the wall. Mark the positions and drill the holes.

### NOTICE

Observe the level and adjust until the bubble is in the middle position. The depth of the holes should be about 70 mm.

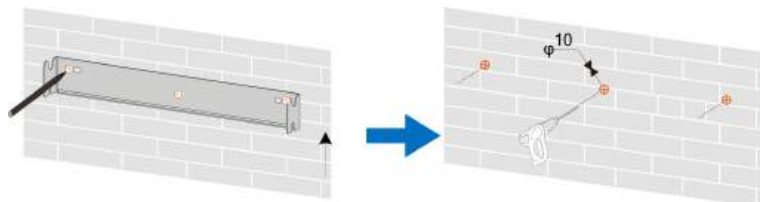

**Step 2** Place the expansion tubes into the holes. Then secure the wall-mounting bracket to the wall firmly with the expansion bolt sets.

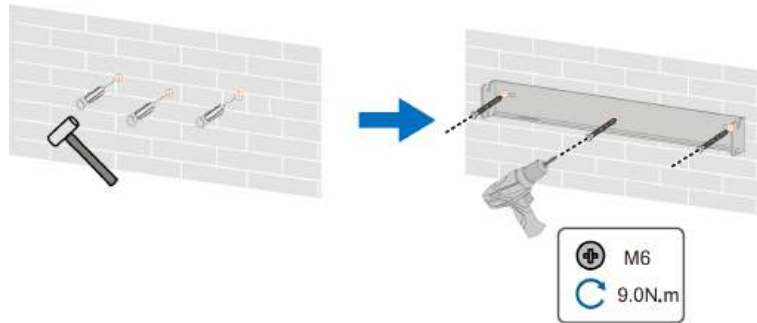

**Step 3** Lift the inverter and slide it down along the wall-mounting bracket to make sure they match perfectly. Use two screw sets to lock both left and right side.

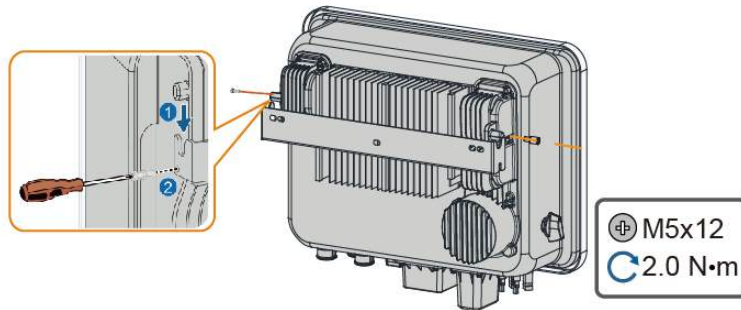

--End

# 6 Electrical Connection

## 6.1 Safety Instructions

### DANGER

The PV string will generate lethal high voltage when exposed to sunlight.

- Operators must wear proper personal protective equipment during electrical connections.
- Must ensure that cables are voltage-free with a measuring instrument before touching DC cables.
- Respect all safety instructions listed in relevant documents about PV strings.

### DANGER

- Before electrical connections, please make sure that the inverter switch and all switches connected to the inverter are set to "OFF", otherwise electric shock may occur!
- Ensure that the inverter is undamaged and all cables are voltage free before performing electrical work.
- Do not close the AC circuit breaker until the electrical connection is complete.

### DANGER

Batteries deliver electric power, resulting in burns or a fire hazard when they are short circuited, or wrongly installed.

Lethal voltages are present at the battery terminals and cables connecting to the inverter. Severe injuries or death may occur if the cables and terminals in the inverter are touched.

### WARNING

Damage to the product caused by incorrect wiring is not covered by the warranty.

- Electrical connection must be performed by professionals.
- Operators must wear proper personal protective equipment during electrical connections.
- All cables used in the PV generation system must be firmly attached, properly insulated, and adequately dimensioned.

**NOTICE**

All electrical connections must comply with local and national / regional electrical standards.

- Cables used by the user shall comply with the requirements of local laws and regulations.
- Only with the permission of the national / regional grid department, the inverter can be connected to the grid.

**NOTICE**

- Before connecting a power cable (such as the AC cable, the DC cable, etc.), confirm that the label and identifier on the power cable are correct.
- Please make sure to divide the AC output cable from the DC input cable during the electrical connection to avoid any possible short circuit.
- When laying out communication cables, separate them from power cables and keep them away from strong interference sources to prevent communication interruption.

**NOTICE**

All vacant terminals must be covered with waterproof covers to prevent affecting the protection rating.

When the wiring is completed, seal the gap of cable inlet and outlet holes with fireproof / waterproof materials such as fireproof mud to prevent foreign matter or moisture from entering and affecting the long-term normal operation of the inverter.

Comply with the safety instructions related to PV strings and the regulations related to the utility grid.



- If excessive loads are connected to the inverter backup port, the inverter will shut down for protection. Please remove some loads and restart the inverter.
- The cable colors in figures in this manual are for reference only. Please select cables according to local cable standards.

## 6.2 Terminal Description

- MG5/6RL:

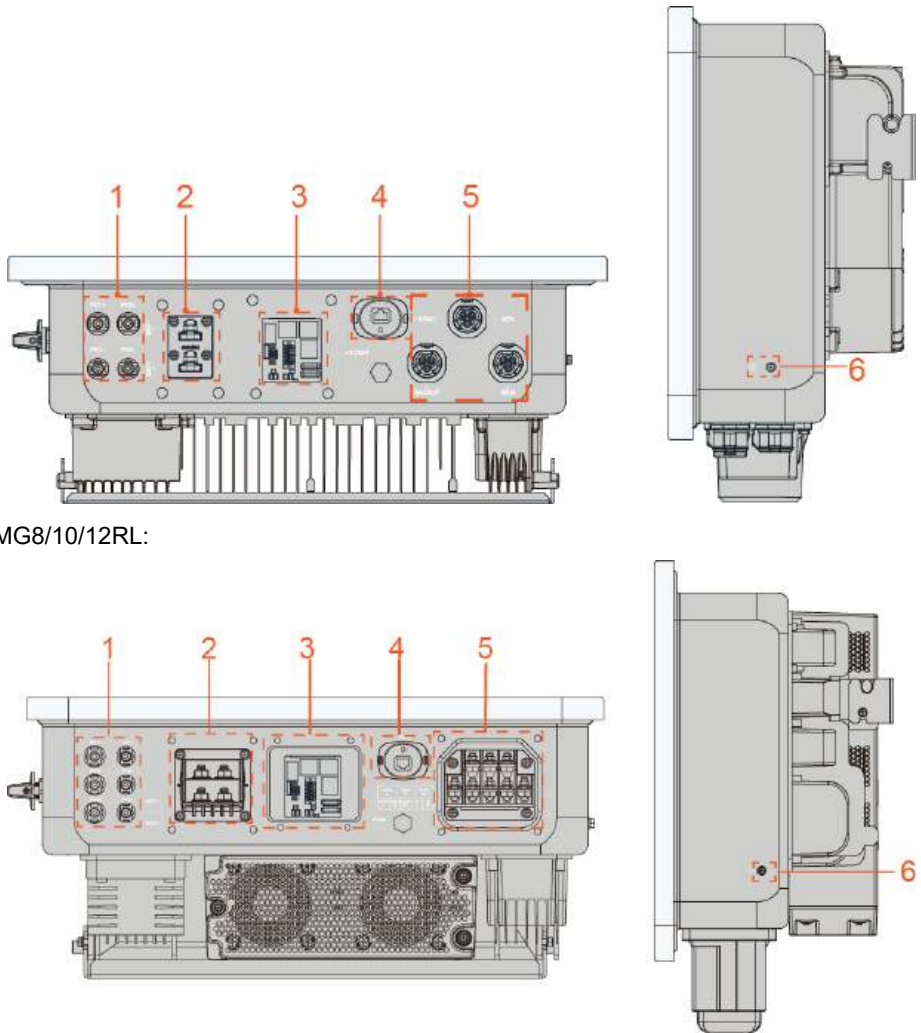

- MG8/10/12RL:

**Figure 6-1** Terminals

\* The image shown here is for reference only. The actual product received may differ.

**Table 6-1** Terminal Description

N o.	Name	Description	Decisive Voltage Classification
1	PV+, PV-	Positive and negative DC input connectors.	DVC-C
2	BAT+, BAT-	Connectors for the battery power cables	DVC-A

N o.	Name	Description	Decisive Voltage Classification
3	COM2	Communication connection for RSD, CT, Meter, RS-485/CAN, DRM, DO.	DVC-A
4	COM1	Communication accessory port to be connected to WiNet-S2 communication module.	DVC-A
5	AC terminal	AC terminal to connect to the grid, backup loads, generator.	DVC-C
6		Additional grounding terminal	Not applicable

The pin definition of COM2 terminal is shown in the following label.

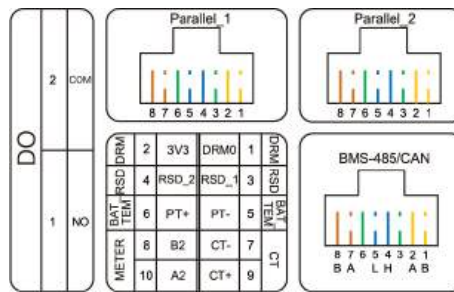

**Figure 6-2** Label of COM2 Terminal

**Table 6-2** Label Description of COM2 Terminal

Label	Description	Description
DO	NO/1, COM/2	For ground fault alarm, intelligent load control or generator control.
Parallel_1	1, 2, 3, 4, 5, 6, 7, 8	For master-slave parallel communication.
Parallel_2	1, 2, 3, 4, 5, 6, 7, 8	For master-slave parallel communication.
DRM	3V3, DRM0	Reserved (Detail availability contact SUNGROW)
RSD	RSD_1, RSD_2	Reserved (Detail availability contact SUNGROW)

Label	Description	
BAT_TEM	PT-, PT+	For temperature sensor used for connecting to the lead-acid battery when the system is configured with lead-acid batteries.
METER	A2, B2	For smart energy meter.
CT	CT-, CT+	For grid CT signal sampling.
BMS-485/ CAN	1/B, 2/A, 3, 4/H, 5/L, 6, 7/A, 8/B	Only 4/H and 5/L are used for li-ion battery communication via CAN protocol. RS485 protocol is reserved. (Detail availability contact SUNGROW)

### 6.3 Electrical Connection Overview

The electrical connection should be realized as follows:

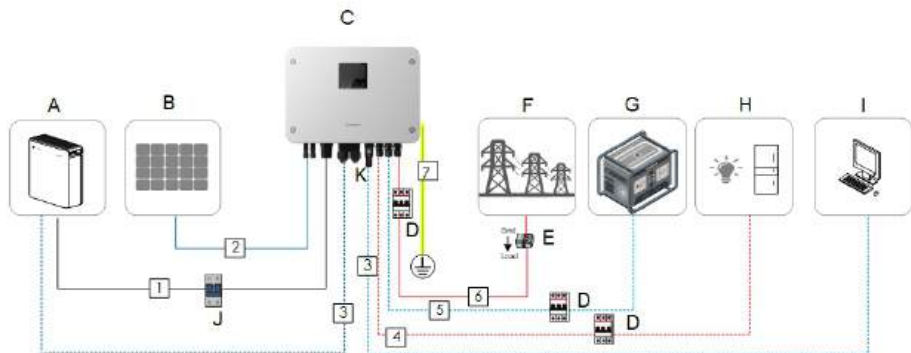

- (A) Battery
- (B) PV string
- (C) Inverter
- (D) AC circuit breaker
- (E) CT
- (F) Grid
- (G) Generator/ Load
- (H) Backup loads
- (I) Monitoring device
- (J) DC Breaker
- (K) WiNet-S2

**⚠ WARNING**  
**Install an AC circuit breaker on the backup side. Otherwise, an electrical short circuit may cause damage to the inverter.**

**NOTICE**

**Ensure that AC output cables are firmly connected. Failing to do so may cause inverter malfunction or damage to its AC connectors.**

**Table 6-3** Cable Requirements

No.	Cable	Type	Cable Diameter	Cross-section
1	Battery power cable	Copper wire cable	/	MG5/6RL: 35 mm <sup>2</sup> –50 mm <sup>2</sup> MG8/10/12RL*: 35 mm <sup>2</sup> –95 mm <sup>2</sup>
2	PV cable	Outdoor multi-core copper wire cable complying with 600 V and 20 A standard	4.7–6.4 mm	4 mm <sup>2</sup> –6 mm <sup>2</sup>
3	Communication cable	Shielded twisted pair	4.8–6 mm	0.5 mm <sup>2</sup> –1.0 mm <sup>2</sup>
		CAT 5E outdoor shielded network cable**	4.8–6 mm	0.08 mm <sup>2</sup> –0.2 mm <sup>2</sup>
4 / 5 / 6	AC cable	Copper wire cable	/	MG5/6RL: 8 AWG MG8/10/12RL: 6 AWG
7	Additional Grounding cable	Copper wire cable	The same as that of the PE wire in the AC cable	

If local standard have other requirements for cables, set the cable specification according to the local standard.

The factors that affect cable selection include rated current, cable type, routing mode, ambient temperature, and maximum expected line loss.

The cabling distance between the battery and the inverter should be less than 8 m, and within 3 m is recommended.

\*Supplementary note on the cross-section of the battery power cable:

- When the battery is directly connected to the inverter, it is sufficient to meet the minimum requirements between the inverter and the battery. Please refer to the manual supplied by the battery manufacturer for the requirements. The requirements for MG8/10/12RL are as follows.
  - When  $I_{\text{Battery}} \leq 135 \text{ A}$ , use  $35 \text{ mm}^2\text{--}50 \text{ mm}^2$  cables.
  - When  $I_{\text{Battery}} > 135 \text{ A}$ , select either one set of  $70 \text{ mm}^2\text{--}95 \text{ mm}^2$  cables or two sets of  $35 \text{ mm}^2\text{--}50 \text{ mm}^2$  cables.
- When the inverter and the battery are connected via a busbar, the cable between the inverter and the busbar must meet the inverter's requirements, and the cable between the busbar and the battery must meet the battery's requirements.

\*\*To meet shielding and anti-interference requirements:

- Shielded Ethernet cables are mandatory. It is recommended to use CAT 5E or CAT 6 shielded cables.
- Use Ethernet cables with magnet cores at both ends, and in some cases, add magnet cores in the middle.

## 6.4 Backup Wiring Diagram



The wiring diagram shown here is for reference only. The actual wiring method shall comply with local requirements.

### For South Africa

For South Africa, the neutral cable of GRID side and BACKUP side must be connected independently to N-Bar. Otherwise BACKUP function will not work.

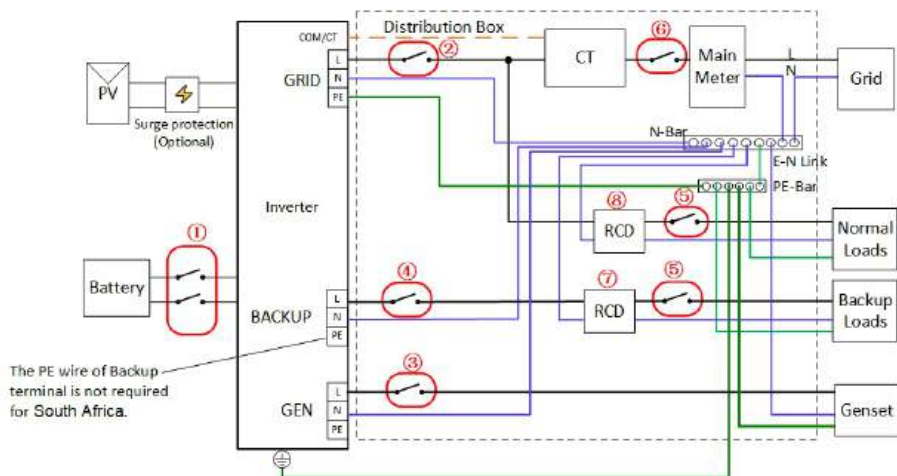

NO.

MG5/6/8/10/12RL

①

MG5/6RL:  $\geq 150 \text{ A}/100 \text{ V DC breaker}^*$

NO.	MG5/6/8/10/12RL
	• MG8/10/12RL: $\geq 250$ A/100 V DC breaker*
②	• MG5/6RL: $\leq 40$ A/230V/400V AC breaker • MG8/10/12RL: $\leq 63$ A/230V/400V AC breaker
③	• MG5/6RL: $\leq 40$ A/230V/400V AC breaker • MG8/10/12RL: $\leq 63$ A/230V/400V AC breaker
④	• MG5/6RL: $\leq 40$ A/230V/400V AC breaker • MG8/10/12RL: $\leq 63$ A/230V/400V AC breaker
⑤	Depends on loads
⑥	Depends on household loads and inverter capacity
⑦ ⑧	30mA RCD (Comply with local regulation)

Note 1: \* If the battery is integrated with a readily accessible internal DC breaker, no additional DC breaker is required.

Note 2: The recommended values in the table are for reference only. The actual values must comply with local standard and actual conditions.

Note 3: The rated current of breaker ② is suggested to lower than that of breaker ⑥.

Note 4: If the rated current of on-site power cables are lower than those recommended above, the breakers specification should be considered to match the power cables in first priority.

Note 5: The AC port takes power from the grid and is set according to the grid circuit breaker.

Note 6: MG8/10/12RL requires no PE connection at its generator terminal.

#### For other countries

For other countries, the following diagram is an example for grid systems without special requirement on wiring connection.

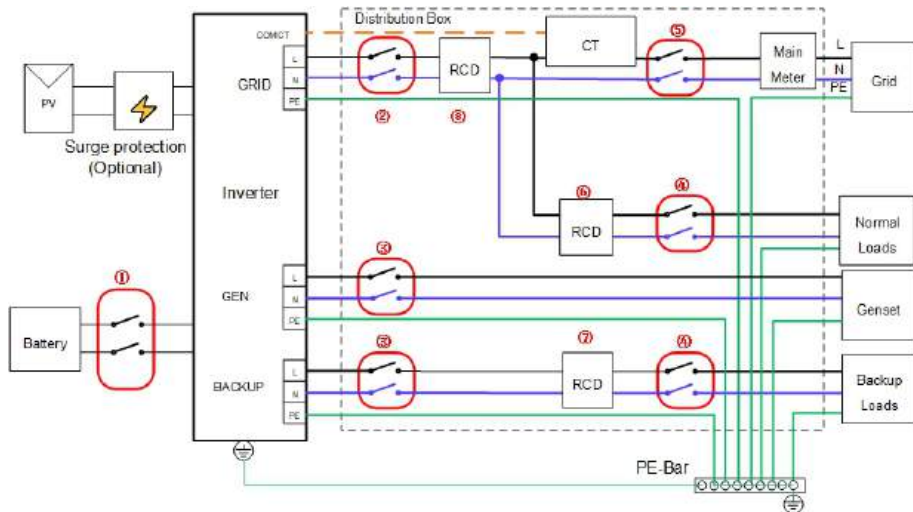

NO.	MG5/6/8/10/12RL
①	<ul style="list-style-type: none"> <li>MG5/6RL: <math>\geq 150</math> A/100 V DC breaker*</li> <li>MG8/10/12RL: <math>\geq 250</math> A/100 V DC breaker*</li> </ul>
②	<ul style="list-style-type: none"> <li>MG5/6RL: <math>\leq 40</math> A/230V/400V AC breaker</li> <li>MG8/10/12RL: <math>\leq 63</math>A/230V/400V AC breaker</li> </ul>
③	<ul style="list-style-type: none"> <li>MG5/6RL: <math>\leq 40</math> A/230V/400V AC breaker</li> <li>MG8/10/12RL: <math>\leq 63</math>A/230V/400V AC breaker</li> </ul>
④	Depends on loads
⑤	Depends on household loads and inverter capacity (Optional)
⑥ ⑦	30mA RCD (Recommended)
⑧	300mA RCD (Recommended)

Note 1: \* If the battery is integrated with a readily accessible internal DC breaker, no additional DC breaker is required.

Note 2: The recommended values in the table are for reference only. The actual values must comply with local standard and actual conditions.

Note 3: The rated current of breaker ② is suggested to lower than that of breaker ⑤.

Note 4: If the rated current of on-site power cables are lower than those recommended above, the breakers specification should be considered to match the power cables in first priority.

Note 5: The AC port takes power from the grid and is set according to the grid circuit breaker.

Note 6: MG8/10/12RL requires no PE connection at its generator terminal.

### Backup wiring diagram (For TT System)

In the TT system, the following diagram is an example for grid systems without special requirement on wiring connection.

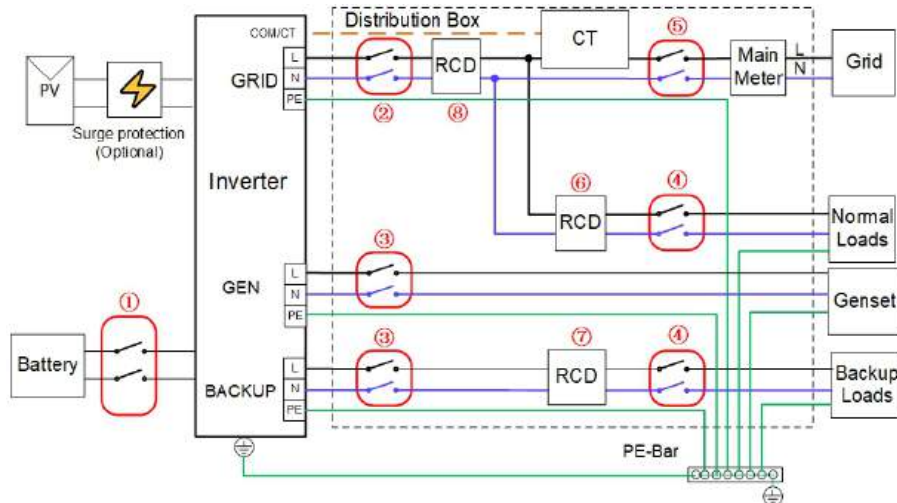

NO.	MG5/6/8/10/12RL
①	<ul style="list-style-type: none"> <li>MG5/6RL: <math>\geq 150</math> A/100 V DC breaker*</li> <li>MG8/10/12RL: <math>\geq 250</math> A/100 V DC breaker*</li> </ul>
②	<ul style="list-style-type: none"> <li>MG5/6RL: <math>\leq 40</math> A/230V/400V AC breaker</li> <li>MG8/10/12RL: <math>\leq 63</math>A/230V/400V AC breaker</li> </ul>
③	<ul style="list-style-type: none"> <li>MG5/6RL: <math>\leq 40</math> A/230V/400V AC breaker</li> <li>MG8/10/12RL: <math>\leq 63</math>A/230V/400V AC breaker</li> </ul>
④	Depends on loads
⑤	Depends on household loads and inverter capacity (Optional)
⑥ ⑦	30mA RCD (Recommended)
⑧	300mA RCD (Recommended)

Note 1: \* If the battery is integrated with a readily accessible internal DC breaker, no additional DC breaker is required.

Note 2: The recommended values in the table are for reference only. The actual values must comply with local standard and actual conditions.

Note 3: The rated current of breaker ② is suggested to lower than that of breaker ⑤.

Note 4: If the rated current of on-site power cables are lower than those recommended above, the breakers specification should be considered to match the power cables in first priority.

Note 5: The AC port takes power from the grid and is set according to the grid circuit breaker.

Note 6: MG8/10/12RL requires no PE connection at its generator terminal.

## 6.5 External Protective Grounding Connection

### DANGER

- **There are large currents during the inverter's operation. If the inverter is powered on and put into operation without being grounded, it may lead to electric shock hazards or failures of major protective functions such as surge protection. Therefore, before powering on the inverter, make sure it has been reliably grounded; otherwise, damages caused therefrom will not be covered by warranty.**
- **When performing electrical connections of the inverter, give the highest priority to grounding. Be sure to carry out the grounding connection first.**

### WARNING

- **Since the inverter is not equipped with a transformer, neither the negative electrode nor the positive electrode of the PV string can be grounded. Otherwise, the inverter will not operate normally.**
- **Connect the grounding terminal to the external protective grounding point before AC cable connection, PV string connection, and communication cable connection.**
- **The external protective grounding point provides a reliable ground connection. Do not use an improper grounding conductor for grounding, Otherwise, it may cause product damage or personal injury.**
- **Depending on Local Rules, please also ground the PV panel subconstruction to the same common grounding point (PE Bar) in addition to local lightning protection rules.**

**⚠ WARNING**

The external protective grounding terminal must meet at least one of the following requirements.

- The cross-sectional area of the grounding cable is not less than 10 mm<sup>2</sup> for copper wire or 16 mm<sup>2</sup> for aluminum wire. It is recommended that both the external protective grounding terminal and the AC side grounding terminal be reliably grounded.
- If the cross-sectional area of the grounding cable is less than 10 mm<sup>2</sup> for copper wire or 16 mm<sup>2</sup> for aluminum wire, ensure that both the external protective grounding terminal and the AC side grounding terminal are reliably grounded.

The grounding connection can be made by other means if they are in accordance with the local standards and regulations, and SUNGROW shall not be held liable for the possible consequences.

### 6.5.1 External Protective Grounding Requirements

All non-current carrying metal parts and device enclosures in the PV power system should be grounded, for example, brackets of PV modules and inverter enclosure.

When there is only one inverter in the PV system, connect the external protective grounding cable to a nearby grounding point.

When there are multiple inverters in the PV system, connect the external protective grounding terminals of all inverters and the grounding points of the PV module brackets to ensure equipotential connections to ground cables (according to the onsite conditions).

### 6.5.2 Connection Procedure

For MG5/6RL, external grounding cable and OT/DT terminal are prepared by customers.

For MG8/10/12RL, external grounding cable is prepared by customers and OT/DT terminal is in the scope of delivery.

**Step 1** Prepare the cable and OT/DT terminal.

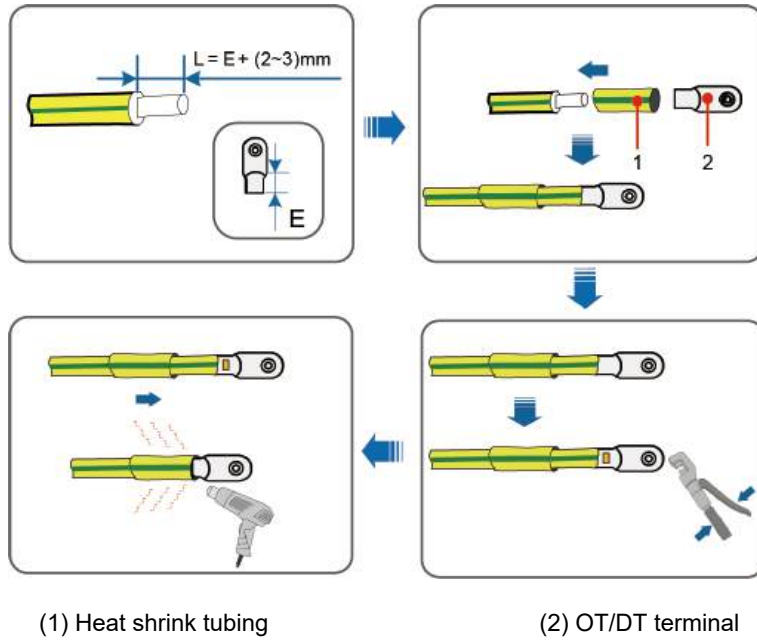

After being crimped, the OT terminal must wrap the wires completely, and the wires must contact the OT terminal closely. When using a heat gun, protect the device from being scorched.

**Step 2** Remove the screw on the grounding terminal and fasten the cable with a screwdriver.

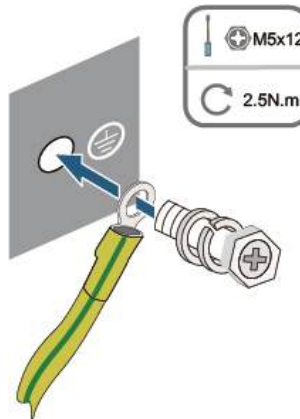

**Step 3** Apply paint to the grounding terminal to ensure corrosion resistance.

--End

## 6.6 AC Cable Connection

### 6.6.1 AC Side Requirements



Only with the permission of the local grid department, the inverter can be connected to the grid.

Before connecting the inverter to the grid, ensure the grid voltage and frequency comply with requirements, for which, refer to "**Technical Data**". Otherwise, contact the electric power company for help.

#### AC Circuit Breaker

An independent circuit breaker must be installed on the output side of the inverter to ensure safe disconnection from the grid. The recommended specifications are as follows.

Inverter Model	Recommended Specification (back-up)	Recommended Specification (on-grid)
MG5/6RL	≤ 40 A	≤ 40 A
MG8/10/12RL	≤ 63 A	≤ 63 A

#### **WARNING**

**AC circuit breakers should be installed on the output side of the inverter and the grid side to ensure safe disconnection from the grid.**

- **Determine whether an AC circuit breaker with greater overcurrent capacity is required based on actual conditions.**
- **Multiple inverters cannot share one AC circuit breaker.**

#### Residual Current Monitoring Device

With an integrated universal current-sensitive residual current monitoring unit included, the inverter will disconnect immediately from the mains power once a fault current with a value exceeding the limit is detected.

However if an external residual current device (RCD) (type A is recommended) is mandatory, the switch must be triggered at a residual current of 300 mA (recommended). RCD of other specifications can also be used according to local standard.

### 6.6.2 AC Cable Connection (MG5/6RL)

#### 6.6.2.1 Connecting the AC Cable

**Step 1** Route the AC cable through the connector.



**Step 2** Strip the cable insulation.

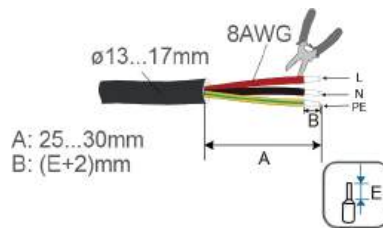

**Step 3** (Optional) If using multi-core cables, crimp the terminals. For single-core cables, skip this step.

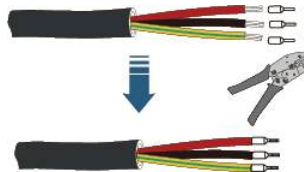

**Step 4** Insert the L, N, and PE wires into their corresponding terminals on the connector and tighten them. Assemble the connector.

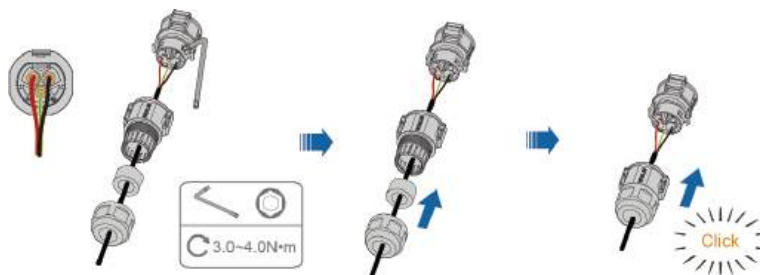

**Step 5** Remove the waterproof cap from the **GRID** port.



**Step 6** Insert the assembled connector into the **GRID** port.

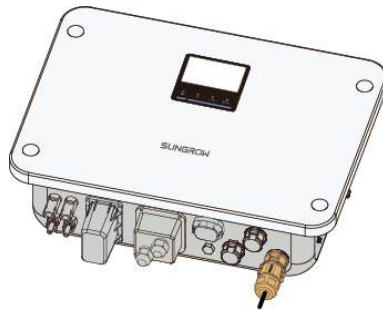

--End

### 6.6.2.2 Backup Connection



Do not short-circuit the Backup port during operation. Otherwise, the inverter or power distribution system will be seriously damaged. The loss is not covered by the SUNGROW warranty.



Risk of inverter damage due to incorrect cable connection. Do not connect the grid power wires to BACKUP port. Observe the plug assignment.

- Do not connect the L line to the "PE" terminal or the PE wire to the "N" terminal. Otherwise, unrecoverable damage to the inverter may follow.
- Do not connect the L line and the N line in reverse, otherwise the inverter may not operate normally.

**Step 1** Route the cable through the connector.

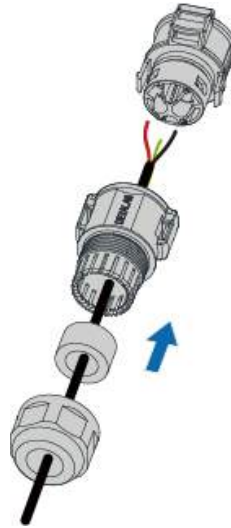

**Step 2** Strip the cable insulation.

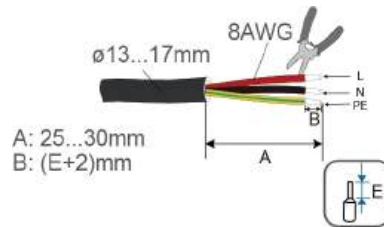

**Step 3** (Optional) If using multi-core cables, crimp the terminals. For single-core cables, skip this step.

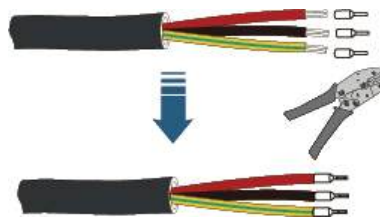

**Step 4** Insert the L, N, and PE wires into their corresponding terminals on the connector and tighten them. Assemble the connector.

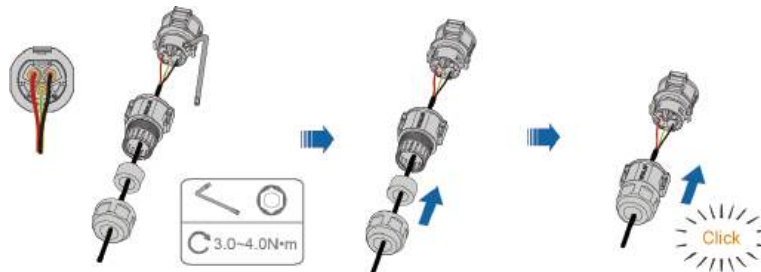

**Step 5** Remove the waterproof cover from the **BACKUP** port.



**Step 6** Insert the assembled connector into the **BACKUP** port.

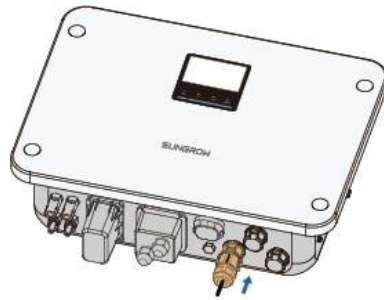

--End

### 6.6.2.3 Generator Connection

Risk of inverter damage due to incorrect cable connection.  
Observe the plug assignment.



- Do not connect the L line to the "PE" terminal or the PE wire to the "N" terminal. Otherwise, unrecoverable damage to the inverter may follow.
- Do not connect the L line and the N line in reverse, otherwise the inverter may not operate normally.



Do not short-circuit the GEN port during operation. Otherwise, the inverter or power distribution system will be seriously damaged. The loss is not covered by the SUNGROW warranty.

**Step 1** Route the cable through the connector.

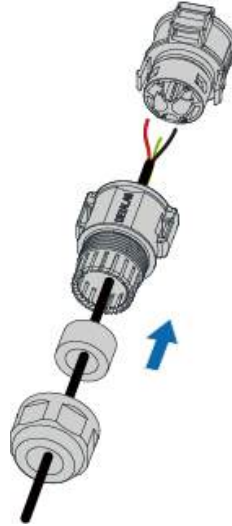

**Step 2** Strip the cable insulation.

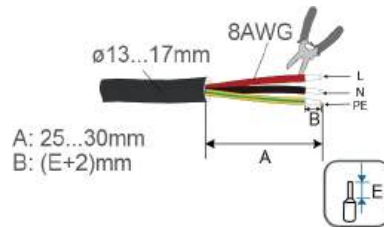

**Step 3** (Optional) If using multi-core cables, crimp the terminals. For single-core cables, skip this step.

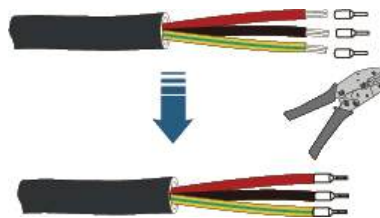

**Step 4** Insert the L, N, and PE wires into their corresponding terminals on the connector and tighten them. Assemble the connector.

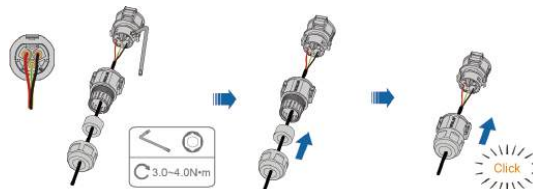

**Step 5** Remove the waterproof cap from the GEN port.



**Step 6** Insert the assembled AC cable connector into the **GEN** port.

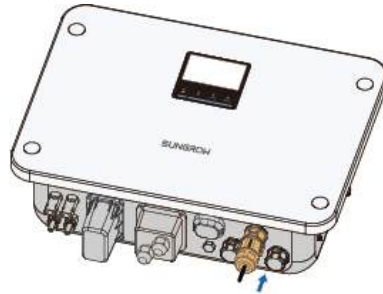

--End

### 6.6.3 AC Cable Connection (MG8/10/12RL)

**Step 1** Switch off the AC side circuit breaker and secure it against reconnection.

**Step 2** Remove the AC terminal cover.

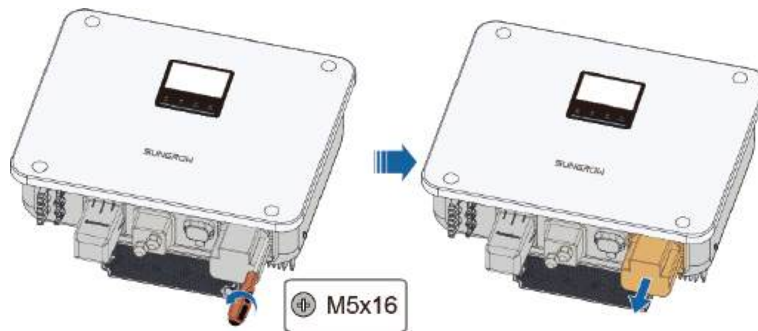

Keep the removed screws for the subsequent installation of the AC connector.

**Step 3** Pierce the corresponding rubber membrane based on the cable being connected.





The AC connector is labeled with BACKUP, GEN, and GRID. Pierce the corresponding rubber membrane based on the cable being connected.

**Step 4** Connect the cables in the following order: BACKUP, GEN, then GRID.

a. Connect the BACKUP cable

1. Route the cable through the BACKUP port.

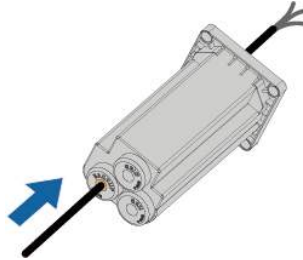

2. Strip the cable insulation.

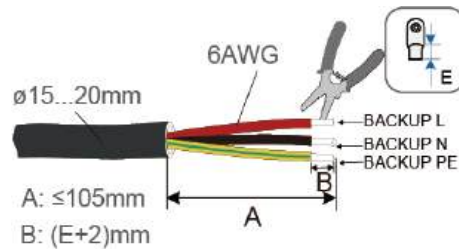

3. Crimp the OT lug onto the cable.

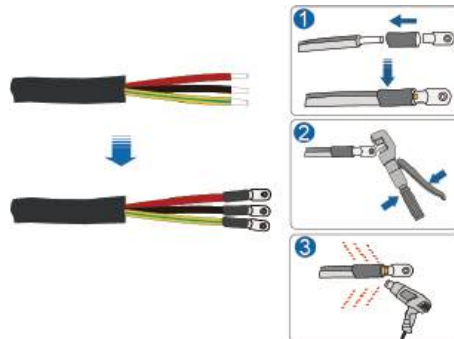

4. Remove the nut from the BACKUP terminal.

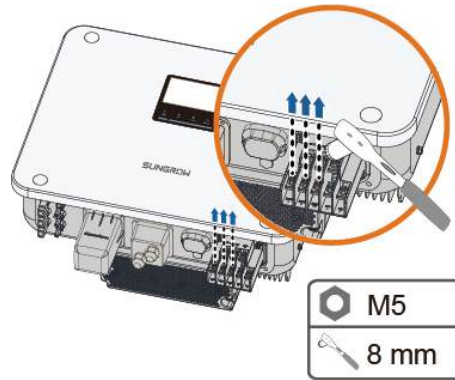

5. Secure the crimped BACKUP cable to its corresponding BACKUP terminal and gently pull the cable backward to ensure firm connection.

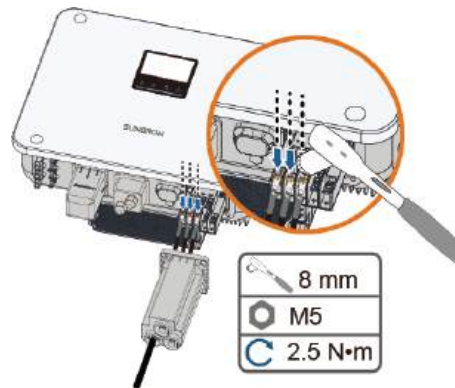

**b. Connect the GEN cable**

1. Route the cable through the GEN port.



2. Strip the cable insulation.

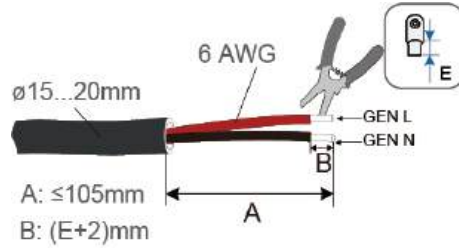

3. Crimp the OT lug onto the cable.

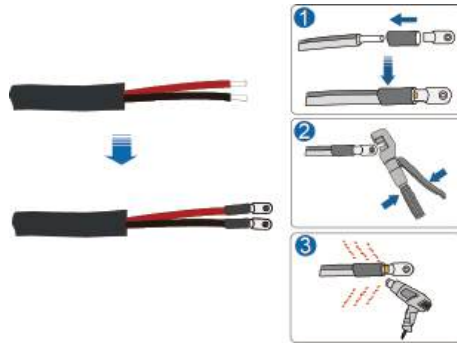

4. Remove the nut from the GEN terminal.



5. Secure the crimped GEN cable to its corresponding GEN terminal and gently pull the cable backward to ensure firm connection.



c. Connect the GRID cable

1. Route the cable through the GRID port.

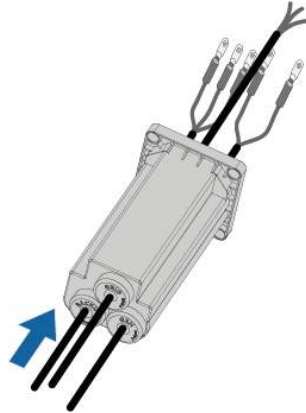

2. Strip the cable insulation.

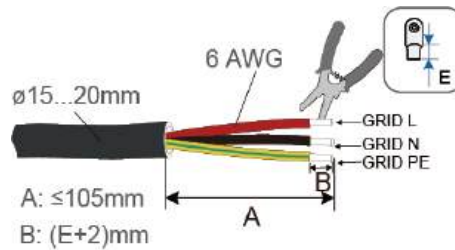

3. Crimp the OT terminal.

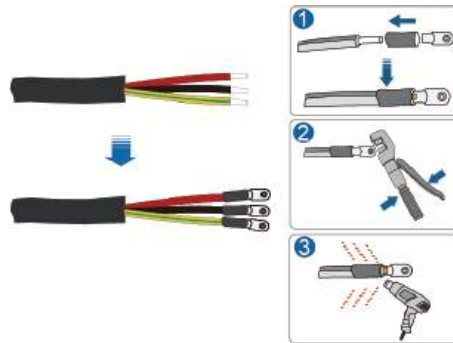

4. Remove the nut from the GRID terminal.

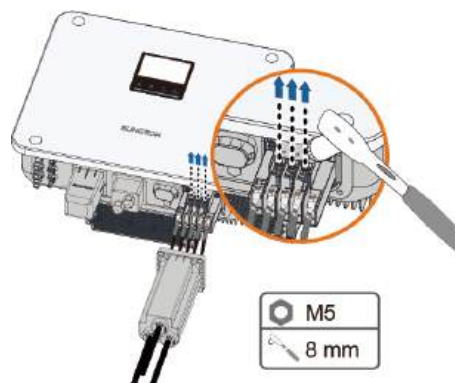

- Secure the crimped GRID cable to its corresponding GRID terminal and gently pull the cable backward to ensure firm connection.

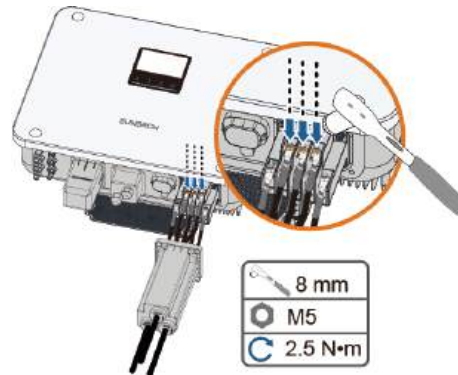

- Step 5** Secure the AC connector housing and gently pull back and confirm that the rubber ring is properly sealed without any curling.

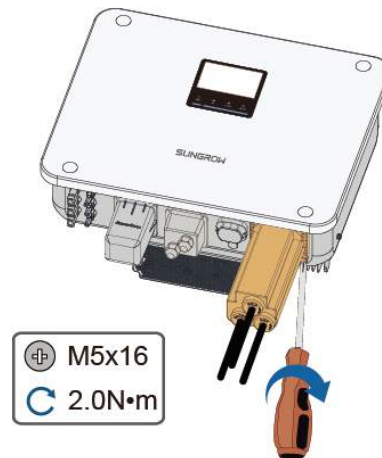

--End

## 6.7 DC Cable Connection

### **⚠ DANGER**

The PV string will generate lethal high voltage when exposed to sunlight.

- Respect all safety instructions listed in relevant documents about PV strings.

**⚠ WARNING**

- **Make sure the PV array is well insulated to ground before connecting it to the inverter.**
- **Make sure the maximum DC voltage and the maximum short circuit current of any string never exceed inverter permitted values specified in "Technical Data".**
- **Check the positive and negative polarity of the PV strings, and connect the PV connectors to corresponding terminals only after ensuring polarity correctness.**
- **During the installation and operation of the inverter, please ensure that the positive or negative electrodes of PV strings do not short-circuit to the ground. Otherwise, an AC or DC short-circuit may occur, resulting in equipment damage. The damage caused by this is not covered by the warranty.**
- **Electric arc or contactor over-temperature may occur if the DC connectors are not firmly in place, and the loss caused is not covered by the warranty.**
- **If the DC input cables are reversely connected or the positive and negative terminals of different MPPT are shorted to ground at the same time, while the DC switch is in the "ON" position, do not operate immediately. Otherwise, the inverter may be damaged.**
- **Use the DC connectors supplied with the product for DC cable connection. Using incompatible DC connectors may result in serious consequences, and the device damage is not covered under warranty.**
- **Do not connect one PV string to multiple inverters. Otherwise, the inverters may be damaged.**

**NOTICE**

**The following requirements about PV string connection must be met. Otherwise, it may cause irreversible damage to the inverter, which is not covered by the warranty.**

**Mixed use of PV modules of different brands or models in one MPPT circuit, or PV modules of different orientation or inclination in a string may not damage inverter, but will cause system bad performance!**

**6.7.1 PV Input Configuration**

- The inverters have two (MG5/6RL) / three (MG8/10/12RL) PV inputs, each with independent MPP tracker. Each DC input area can operate independently.
- The PV strings to two (MG5/6RL) / three (MG8/10/12RL) DC input areas may differ from each other, including PV module type, number of PV modules in each string, angle of tilt, and installation orientation.
- MG5/6RL:

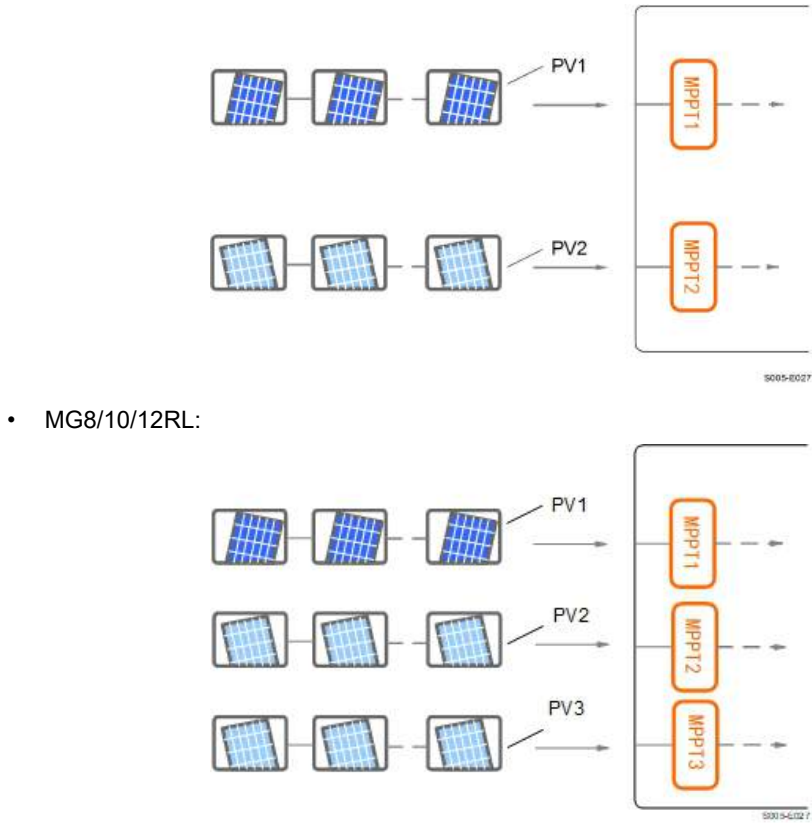

- MG8/10/12RL:

**Figure 6-3** PV Input Configuration

Prior to connecting the inverter to PV inputs, the following electrical specifications must be met simultaneously:

Inverter Model	Open-circuit Voltage Limit	Max. Current for Input Connector
MG5/6/8/10/12RL	500 V	25 A



The open-circuit voltage of each PV string,  $V_{OC}$ , is equal to the number of PV modules multiplied by the open-circuit voltage of the PV module.  $V_{bat}$  represents the lower limit of battery operating voltage range. The  $V_{OC}$  should be less than or equal to 9 times  $V_{bat}$ .

## 6.7.2 Assembling the PV Connectors

### **⚠ DANGER**

**High voltage may be present in the inverter!**

- **Ensure all cables are voltage-free before performing electrical operations.**
- **Do not connect the DC switch and AC circuit breaker before finishing electrical connection.**

**i** To ensure IP65 protection, use only the supplied connector.

**Step 1** Strip the insulation from each DC cable by 7 mm–8 mm.

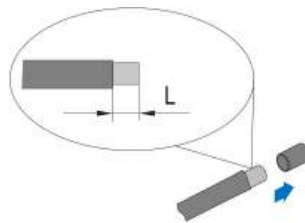

**Step 2** Assemble the cable ends with the crimping pliers.

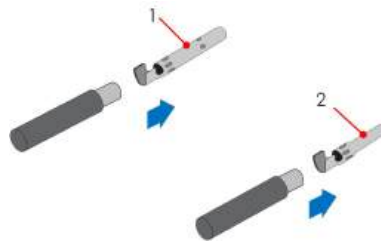

1: Positive crimp contact

2: Negative crimp contact

**Step 3** Lead the cable through cable gland, and insert the crimp contact into the insulator until it snaps into place. Gently pull the cable backward to ensure firm connection. Tighten the cable gland and the insulator (torque 2.5 N.m to 3 N.m).



**Step 4** Check for polarity correctness.

**NOTICE**

If the PV polarity is reversed, the inverter will be in a fault or alarm state and will not operate normally.

--End

**6.7.3 Installing PV Connector**

**Step 1** Rotate the DC switch to "OFF" position.

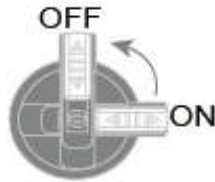

**Step 2** Check the cable connection of the PV string for polarity correctness and ensure that the open circuit voltage in any case does not exceed the inverter input limit of 500V.

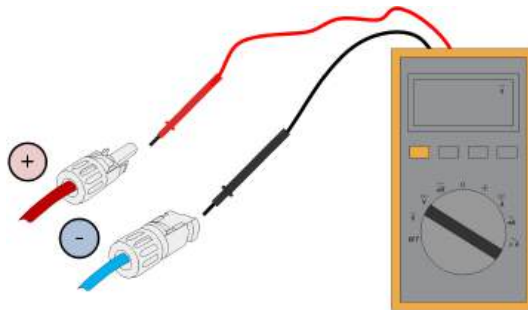
**NOTICE**

The multimeter must have a DC voltage range of at least 500 V. If the voltage is a negative value, the DC input polarity is incorrect. Please correct the DC input polarity. If the voltage is greater than 500 V, too many PV modules are configured to the same string. Please remove some PV modules.

**Step 3** Connect the PV connectors to corresponding terminals until there is an audible click.

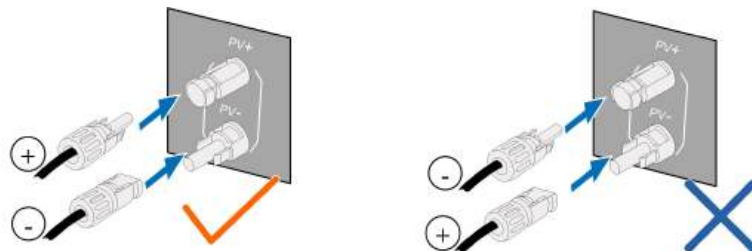

**Step 4** Follow the foregoing steps to connect PV connectors of other PV strings.

**Step 5** Seal any unused PV terminal with a terminal cap.

--End

## 6.8 Battery Power Connection

### 6.8.1 Battery Connection Requirements

This section mainly describes the cable connections on the inverter side. Refer to the instructions supplied by the battery manufacturer for the connections on the battery side and configuration.

#### WARNING

Only use properly insulated tools to prevent accidental electric shock or short circuits. If insulated tools are not available, use electrical tape to cover the entire exposed metal surfaces of the available tools except their tips.

#### WARNING

The connection operation must be performed by trained electricians.

#### WARNING

Do not disconnect under load!  
Battery connectors must not be disconnected while under load. They can be placed in a no load state by shutting down the inverter completely.

#### WARNING

During the installation and operation of the inverter, please ensure that the positive or negative polarities of batteries do not short-circuit to the ground. Otherwise, an AC or DC short-circuit may occur, resulting in equipment damage. The damage caused by this is not covered by the warranty.

 If the hybrid inverter is not connected to a battery, it will not support reliably the backup function.  
The battery should be connected to the common grounding of the house (PE Bar) rather than directly to the inverter PE.  
The energy in the battery will not backfeed into the PV modules.

### 6.8.2 Battery Connection Procedure

#### 6.8.2.1 Assembling the Battery Connectors (MG5/6RL)

- 
- Do not reverse the positive and negative terminals of the battery. Otherwise, the inverter may be damaged.
  - Ensure the battery cable length is less than 8 m.

**Step 1** Strip the cable insulation.

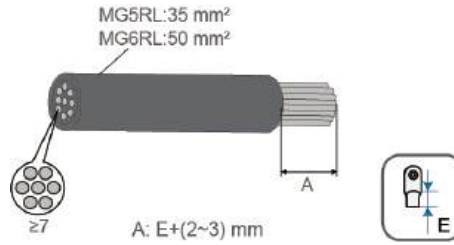

**Step 2** Loosen the swivel nut on the battery connector.

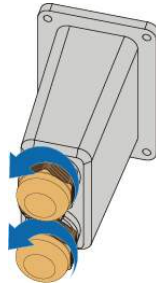

**Step 3** Route the cable sequentially through the swivel nut and housing.



**Step 4** Crimp the OT/DT terminals.

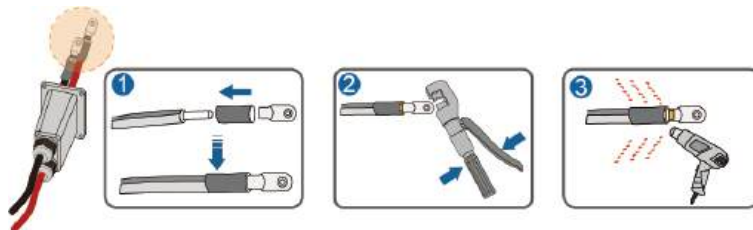

After connecting and securing the battery cables, tighten the nut on the battery connector.

**Step 5** Loosen the screws and remove the battery cover on the inverter side.

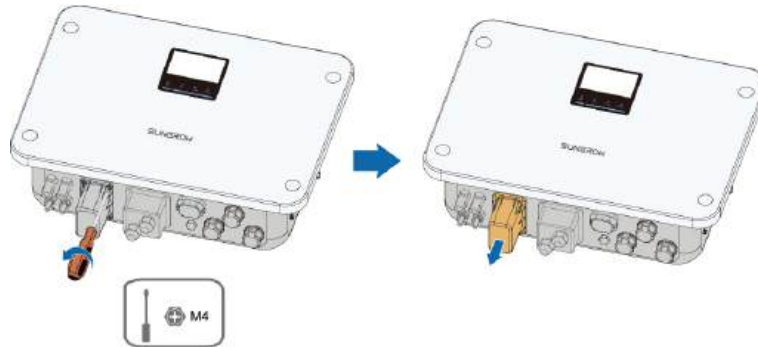

**Step 6** Loosen the nut on the battery side.



**Step 7** Connect cables to corresponding terminals and tighten them securely.



**i** Battery polarity must be correct.

**Step 8** Fully tighten the battery connector's nut and secure the connector.



--End

### 6.8.2.2 Assembling Battery Connector (MG8/10/12RL)

**i** Ensure correct polarity. Reversing positive and negative will cause damage.

**Step 1** Strip the cable insulation.

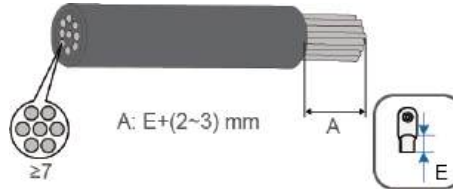





- When the battery is directly connected to the inverter, it is sufficient to meet the minimum requirements between the inverter and the battery. Select the cable cross-section based on the battery current:
  - When  $I_{\text{Battery}} \leq 135 \text{ A}$ , use  $35 \text{ mm}^2$ – $50 \text{ mm}^2$  cables.
  - When  $I_{\text{Battery}} > 135 \text{ A}$ , select either one set of  $70 \text{ mm}^2$ – $95 \text{ mm}^2$  cables or two sets of  $35 \text{ mm}^2$ – $50 \text{ mm}^2$  cables.
- When the inverter and the battery are connected via a busbar, the cable between the inverter and the busbar must meet the inverter's requirements, and the cable between the busbar and the battery must meet the battery's requirements.

**Step 2** Loosen the swivel nut on the battery connector.

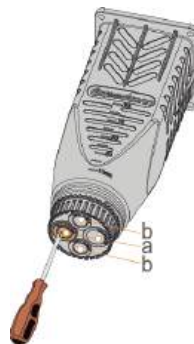

**Step 3** Remove the corresponding rubber sealing ring based on the cable diameter.



	Cable Diameter	Remove Sealing Ring
a	11–14mm	/
	14–16mm	
	16–19mm	
b	11–14mm	/
	14–16mm	

**Step 4** Route the cables through the swivel nut and housing in order, then crimp the OT/DT lug.

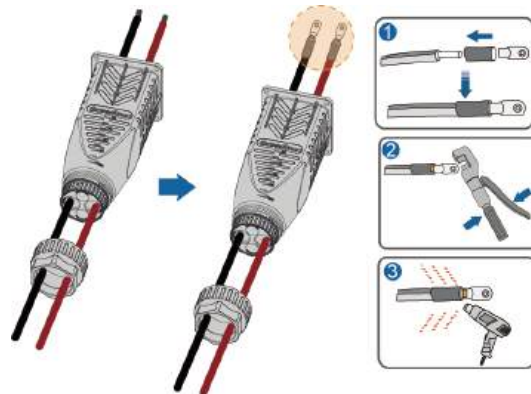

**Step 5** Loosen the screws and remove the battery terminal cover on the inverter side.

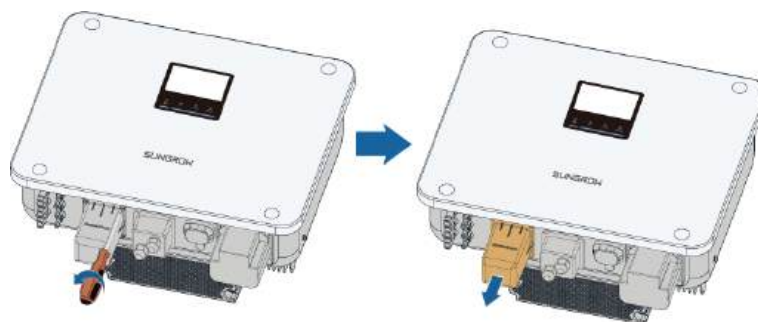

 M5



Keep the removed screws for the subsequent installation of the battery connector.

**Step 6** Loosen the nuts from the battery terminals.

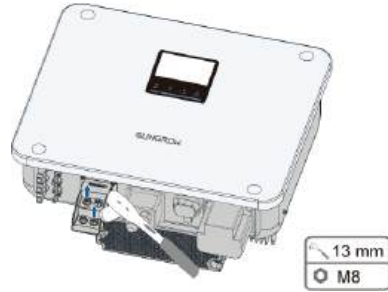

**i** To prevent accidental contact, when only one battery string is connected, it is recommended to wire the cables to the diagonal terminals as shown.

**Step 7** Connect the positive and negative battery cables to their corresponding battery terminals on the inverter and tighten them.

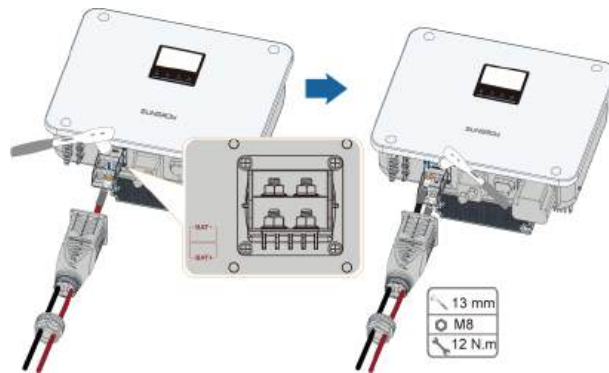

**i** Ensure the battery polarity is not reversed.

To prevent accidental contact, it is recommended that the raised sides of the positive and negative OT lugs face away from each other (back-to-back) during installation, as shown.



**Step 8** After the battery connector is securely fastened, tighten its swivel nut.



--End

## 6.9 Communication Connection

### WLAN function

With the WiNet-S2 module installed, view corresponding information through iSolarCloud App or iSolarCloud Web.

### LAN function

Through the Modbus TCP/IP protocol from the third party can fully control the on/off, derating, charging and discharging of the inverter.

### RS485 function

The RS485 communication interfaces are used to establish communication connection with monitoring devices.



As the communication port features and electrical connection sequences are the same for MG5/6/8/10/12RL, the diagrams in this section are based on MG5/6RL model.

### 6.9.1 WiNet-S2 Connection

The WiNet-S2 module supports Ethernet communication and WLAN communication. It is not recommended to use both communication methods at the same time.

For details, see the quick guide for the WiNet-S2 module. Scan the following QR code for the quick guide.





The software of Winet-S2 is applicable after upgrading to version WINET-SV300.001.03.P030 or later.

### 6.9.1.1 WLAN Communication

**Step 1** Remove the waterproof lid from the **COM1** terminal.

**Step 2** Install the module. Slightly shake it by hand to determine whether it is installed firmly, as shown below.

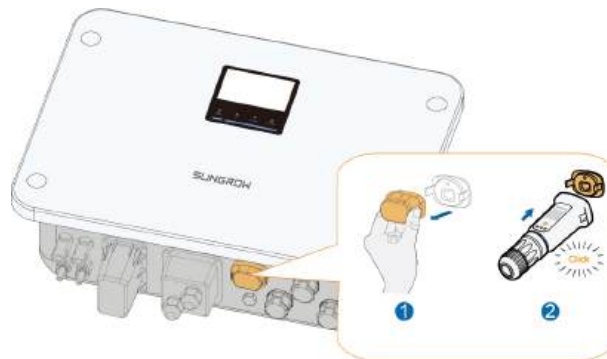

**Step 3** Refer to the guide delivered with the module for the set-up.

--End

### 6.9.1.2 Ethernet Communication

**Step 1 (Optional)** Strip the insulation layer of the communication cable with an Ethernet wire stripper, and lead the corresponding signal cables out. Insert the stripped communication cable into the RJ45 plug in the correct order, and crimp it with a crimper.

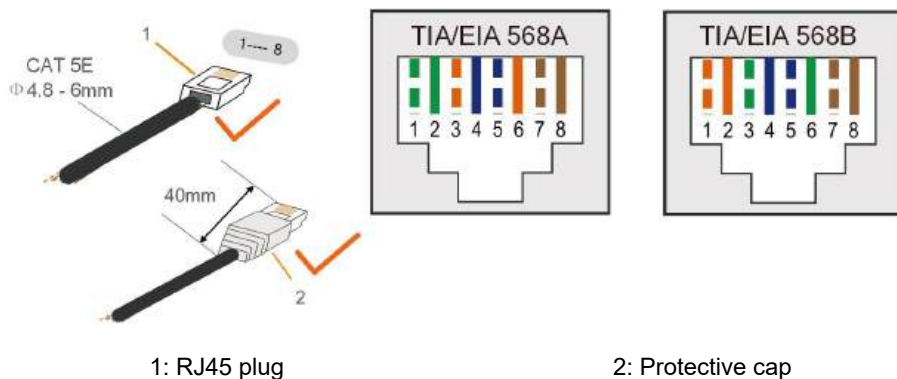

Skip this step if a standard network cable with RJ45 plug is prepared.

**Step 2** Unscrew the swivel nut from the communication module and take out the inner sealing ring.

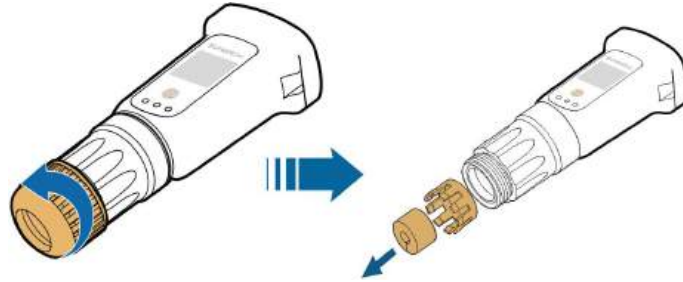

**Step 3** Unscrew the housing from the communication module.

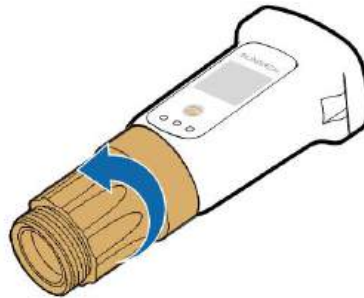

**Step 4** Thread the network cable through the swivel nut and gasket. Afterwards, route the cable into the opening of the sealing. Finally, insert the cable through the housing.

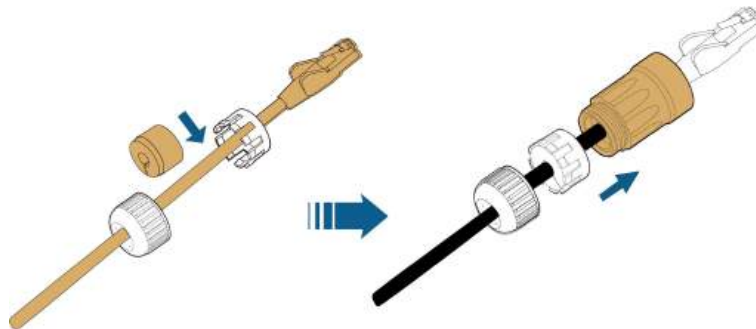

**Step 5** Insert the RJ45 plug into the front plug connector until there is an audible click and tighten the housing. Install the gasket and fasten the swivel nut.

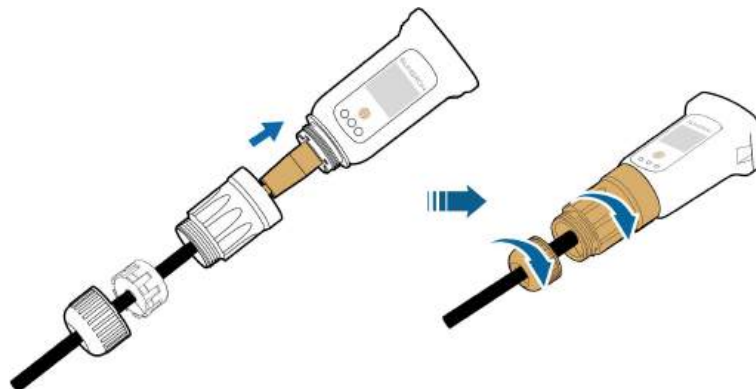

**Step 6** Remove the waterproof lid from the terminal and install WiNet-S2.

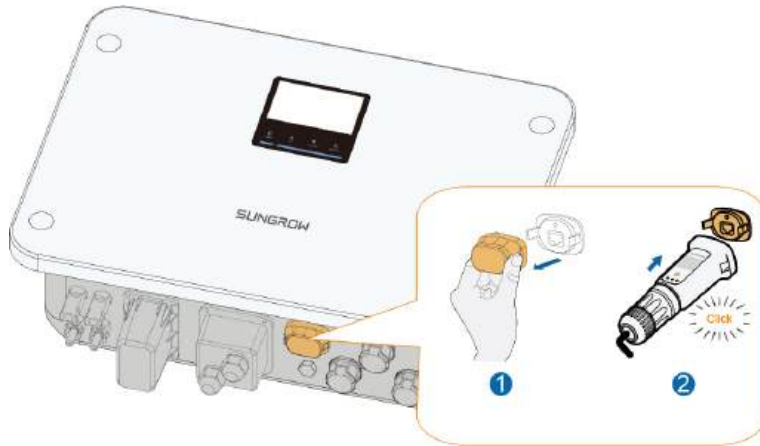

**Step 7** Slightly shake it by hand to determine whether it is installed firmly.

--End

### 6.9.2 COM2 Terminal Communication Connection

COM2 terminal is used for establishing RS485 communication with devices such as the CT and battery.

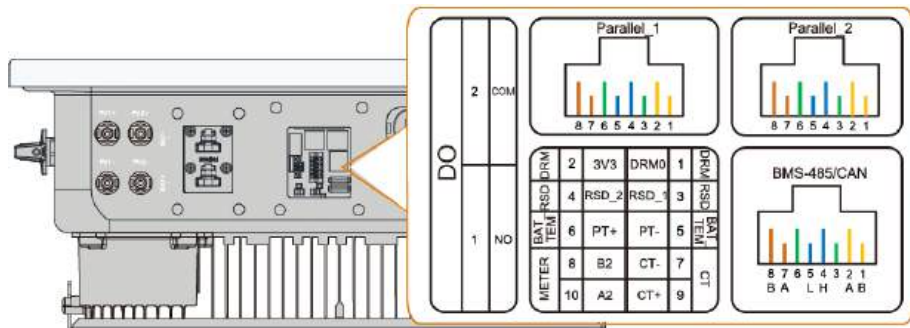

#### 6.9.2.1 CT Connection

**Step 1** Loosen the communication box and route the crimped CT cables through it.

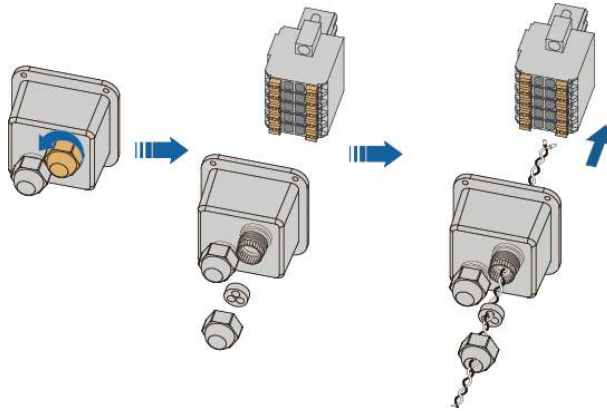

**Step 2** Connect the CT wire ends to the CT+ and CT- terminals on the pluggable connector, and mount the CT on the L line.

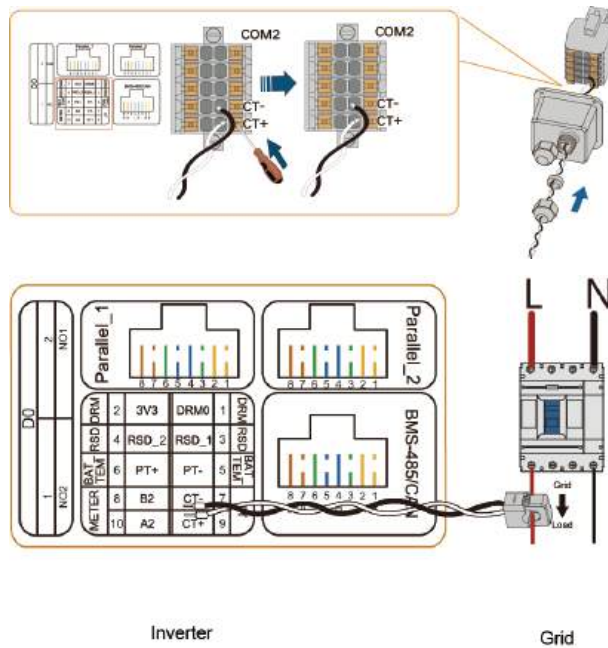

When installing the CT, ensure that the arrow on the CT points from the grid towards the inverter (direction of current flow through the CT).

**Step 3** Hand-tighten the communication box.

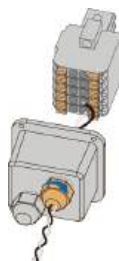

**Step 4** After securing the pluggable connector to the bottom of the inverter, secure the communication box.

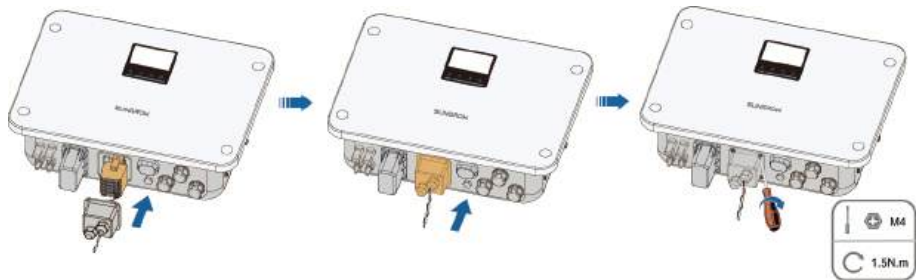

--End

### 6.9.2.2 Smart Energy Meter Connection

The inverter can provide export control when connected to an external smart meter.

- i** The smart energy meter is mainly used to detect the direction and magnitude of the current. And the energy meter data may not be used for billing purposes.
- i** The smart energy meter is not included as standard but is available for separate purchase.

Remove the cable jacket and strip the wire insulation.

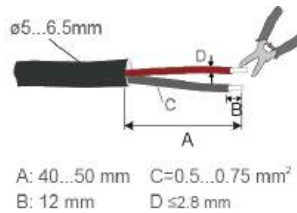

When using a multi-strand wire cable, connect the wire head to the cord end terminal. In case of single-strand copper wire, skip this step.

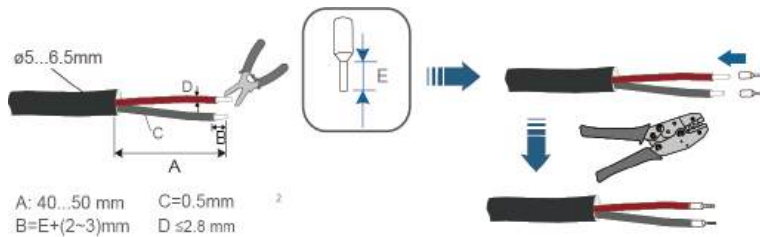

The wire end is connected to the smart energy meter, and the other end is inserted into the METER port of the plug-in connector.

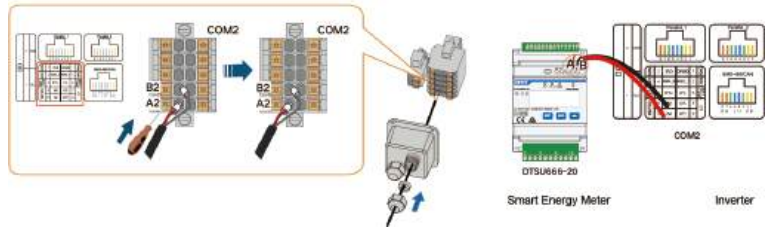

If the communication distance ( $L$ )  $\leq 10$ m, use a RS485 communication cable for connection directly. If  $L > 10$ m, add an extra  $120\Omega$  resistor to improve the communication quality.

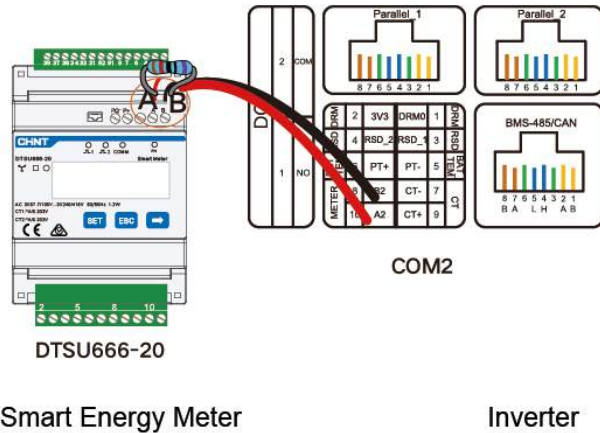

### 6.9.2.3 DO Communication

DO is mainly used for ground fault alarm, intelligent load control or generator control.

Plug the wires into the DO (COM, NO) terminal of the COM2 terminal.

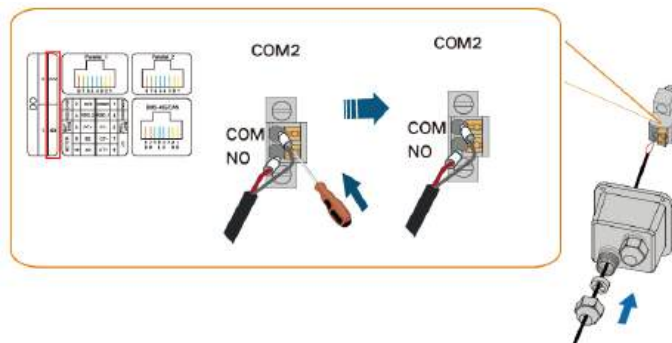

### 6.9.2.4 Li-ion Battery Communication Connection



This is the description of connection to the li-ion battery communication cable on the hybrid inverter side. Consult the manual of the battery for the description of connection on the battery side.



Battery

Inverter

Plug the RJ45 into the BMS-485/CAN terminal of the COM2 terminal.

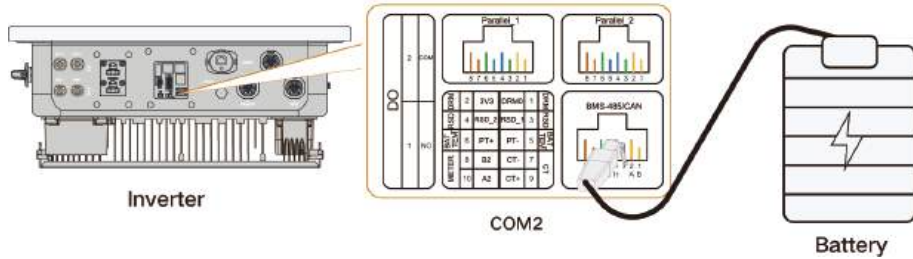

**NOTICE**

**Before connecting the communication cable, ensure the wire sequence is consistent.  
If another model of battery is used, please refer to the corresponding product manual.**

### 6.10 Temperature Sensor Connection

When the system is equipped with a lead-acid battery, it is recommended to connect the PT100 temperature sensor to the inverter. This is to sample the battery temperature or the external environment temperature of the battery.

**Step 1** Crimp the terminals.

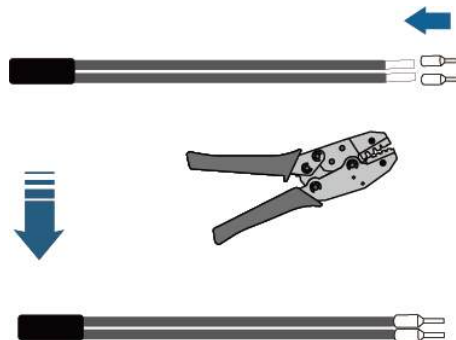

**Step 2** Loosen the communication box and route the crimped PT100 cables through it.

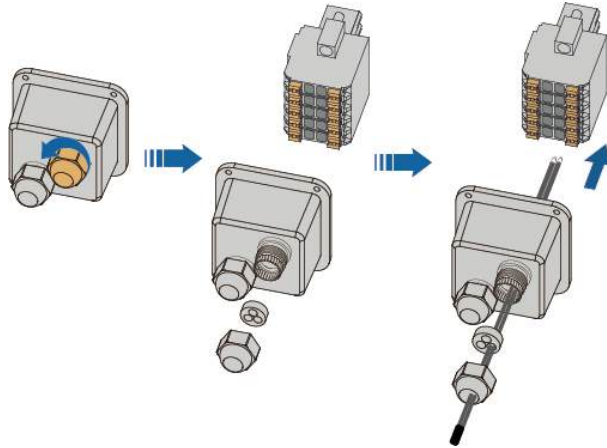

**Step 3** Connect the PT100 wire ends to the PT+ and PT- terminals on the pluggable connector.

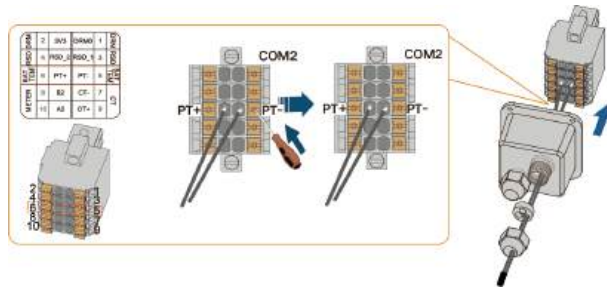

**Step 4** Hand-tighten the communication box.

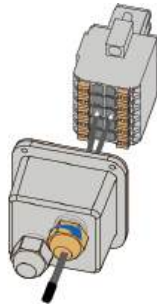

**Step 5** After securing the pluggable connector to the bottom of the inverter, secure the communication box.





It is recommended to place the temperature sensor on the side of the battery located in the center of the battery cluster. This ensures that the system monitors the worst-case temperature conditions, preventing thermal runaway during charging or battery damage caused by local overheating.

**--End**

# 7 Commissioning/Startup Procedure

## 7.1 Inspection Before Commissioning

Check the following items before starting the inverter:

- All equipment has been reliably installed.
- DC switch(es) and AC circuit breaker are in the "OFF" position.
- The ground cable is properly and reliably connected.
- The AC cable is properly and reliably connected.
- The DC cable is properly and reliably connected.
- The communication cable is properly and reliably connected.
- The unused terminals are sealed.
- No foreign items, such as tools, are left on the top of the machine or in the junction box (if there is).
- The AC circuit breaker is selected in accordance with the requirements of this manual and local standards.
- All warning signs & labels are intact and legible.

## 7.2 Commissioning Procedure

If all of the items mentioned above meet the requirements, proceed as follows to start up the inverter for the first time.

**Step 1** Rotate the DC switch to "ON". The DC switch is integrated in the inverter.

**Step 2** Turn on the AC circuit breaker between the inverter and the grid.

**Step 3** Power on the battery circuit breaker.

**Step 4** Power on the button on the battery.

**Step 5** Observe the LED indicator to ensure that the inverter operates normally. (Refer to [2.4 LCD Screen](#)).

**Step 6** If the irradiation and grid conditions meet requirements, the inverter will normally operate. The connection time for inverter to grid may take some minutes or even to more according to different country code chosen in the initial settings and the real site grid condition.

--End



- Wait 5 minutes after completing the previous step before proceeding to the next one.
- Strictly follow the preceding sequence. Otherwise, the product may be damaged, and the loss caused is not covered by the warranty.
- Before closing the AC circuit breaker between the inverter and the power grid, use a multimeter that is set to the AC gear to ensure that the AC voltage is within the specified range. Otherwise, the inverter may be damaged.

## 7.3 App Preparation

**Step 1** Install the iSolarCloud App with latest version. Refer to [9.2 Install iSolarCloud](#).

**Step 2** Register an account. Refer to [9.4 Device Commissioning](#). If you have got the account and password from the distributor/installer or SUNGROW, skip this step.

**Step 3** Download the firmware package to the mobile device in advance. Refer to [9.4 Device Commissioning](#). This is to avoid download failure due to poor on-site network signal.

--End

## 7.4 Creating a Plant

For creating a plant, please refer to the **Create a Plant** section in [iSolarCloud App User Manual](#) to create a plant.

# 8 LCD Screen Operation

After installation and power-on, the system can be configured via the LCD screen.

## 8.1 Initialization Settings



Click “Go to Set” to start the initialization setup process.



The LCD initialization wizard will be activated in either of the following cases:

- When the inverter is powered on for the first time after installation and wiring.
- After a factory reset.

### Basic Settings

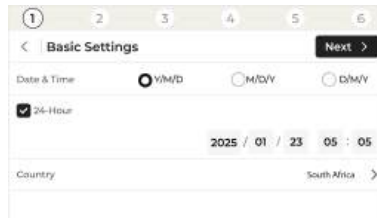

Parameter	Description
Date&Time	Set according to user preference. <ul style="list-style-type: none"><li>• Y/M/D: Year/Month/Day format (Default)</li><li>• M/D/Y: Month/Day/Year format</li><li>• D/M/Y: Day/Month/Year format</li></ul> Time format: HH:MM <ul style="list-style-type: none"><li>• <input checked="" type="checkbox"/> 24-Hour: 24-hour format (Default)</li><li>• <input type="checkbox"/> 24-Hour: 12-hour format, with AM (morning) or PM (afternoon) selected.</li></ul>
Country	Supported settings:

Parameter	Description
	South Africa, Others(50Hz), Others(60Hz) , Thailand-PEA, Thailand-MEA, etc.

### Grid Settings

 The settings are only effective for on-grid running.

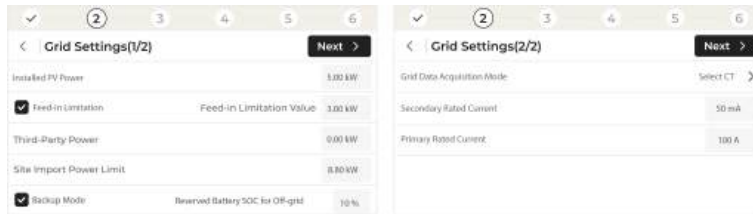

Parameter	Description
Installed PV Power	Default: Inverter's rated AC power. Can be set to match the PV system's installed capacity. Configure according to local regulations.
Feed-in Limitation	Check this if local regulations limit feed-in power. Once checked, set <b>Feed-in Limitation Value</b> according to local regulations. For a multi-unit system, always check the master inverter. When checked, its value shall be set according to the local grid limitations. For a retrofitting the existing PV system, <b>Feed-in Limitation Value</b> ≥ rated power of the third-party PV inverter.
Third-Party Power	Currently unsupported. Set to 0. Applicable to retrofitting the existing PV system, set according to the rated power of the existing PV inverter.
Site Import Power Limit	When the system has high-power loads running and the battery is in forced charging, the household main circuit breaker may trip if the grid draw is too high. Set a <b>Site Import Power Limit</b> based on the main circuit breaker's specification. <b>Recommended limit = breaker current rating × grid voltage.</b>
Backup Mode	If the backup port supplies emergency loads, check <b>Backup Mode</b> and set <b>Reserved Battery SOC for Off-grid</b> so loads run normally during a grid outage.

Parameter	Description
	<p>When the system is on-grid running, the battery will stop discharging once it reaches the <b>Reserved Battery SOC for Off-grid</b>. The battery can only continue to discharge when the system switches to off-grid running.</p> <p>Set <b>Reserved Battery SOC for Off-grid</b> reasonably based on the power and expected runtime of the loads connected to the backup port, and the system's battery capacity.</p> <p>For an emergency load with a power of 300 W running for 24 hours, the total energy required is 7.2 kWh. If the battery capacity is 15.0 kWh, <b>Reserved Battery SOC for Off-grid</b> should be set to 48% (7.2 kWh / 15.0 kWh) to ensure a sufficient energy supply for the emergency load during a grid outage.</p>
Grid Data Acquisition Mode	<ul style="list-style-type: none"> <li>• Select CT (Default) <sup>1</sup></li> <li>• Select Meter<sup>2</sup></li> <li>• Select Whole-home Backup<sup>3</sup></li> </ul>

1. This option is used when the inverter is connected to a CT. The default CT provided with the inverter is rated at 100 A / 50 mA.
  - Secondary Rated Current: The secondary side current, i.e., the output current from the CT to the inverter. When using the 100 A / 50 mA CT, set the Secondary Rated Current to 50 mA.
  - Primary Rated Current: This refers to the grid-side sampling current. When using the 100 A / 50 mA CT, set the Primary Rated Current to 100 A.



Select an appropriate CT based on the sampling current on grid-connected point. When it exceeds 100 A, you can contact SUNGROW for a solution. Purchasing CTs from other brands or of other specifications by yourself may affect the feed-in control accuracy. SUNGROW shall not be held liable for any related responsibilities.

2. This option is used when the inverter is connected to a smart energy meter. The supported meter model is DTSU666-20, with an external CT rated at 100 A / 333 mV. The meter and CT are not included and must be purchased separately from SUNGROW.



- CT Ratio: The default value is 1, which corresponds to a CT rated at 100 A / 333 mV. Select the CT specification according to the grid connection point current. If the sampling current exceeds 100 A, contact SUNGROW for a higher-rated CT.
- Control Phase Selection: DTSU666-20 is a three-phase meter that defaults to Phase A connection. If connected to another phase, update this setting to match the actual wiring.
- Meter Communication Detection: Enable this option to trigger fault code 514 if RS485 communication between the meter and inverter is abnormal.

3. This option is used when the inverter is not connected to a CT or smart energy meter.

If all household loads are connected to the inverter's backup port (whole-home backup scenario), the system can operate without installing a CT or meter.

If a CT or smart energy meter is still connected in a whole-home backup scenario, make sure to choose from Select CT, Select Meter, or Select Whole-home Backup based on the actual setup.

## Battery Settings

Setting	Value
Battery Type	Lithium Battery
Battery Capacity Setting	00.00 kWh
Max. Charging Current	20 A
Max. Discharging Current	20 A
Battery Communication Protocol No.	0

Parameter	Description
Battery Type	<ul style="list-style-type: none"> <li>No Battery*</li> <li>Lithium Battery</li> <li>SOC-Based Control Mode</li> </ul>
Battery Capacity Setting	<p>Refer to the battery specifications provided by the supplier.**</p> <ul style="list-style-type: none"> <li>When the <b>Lithium Battery</b> is online and capacity is read, the setting field displays the read capacity as grayed-out. When online but capacity cannot be read, it can be set. Unit: kWh</li> <li>When the <b>SOC-Based Control Mode</b> is online, manually enter the value. (= battery Ah per cluster × number of battery cluster) Unit: Ah</li> </ul>
Max. Charging Current	The maximum battery charging current set by the inverter.** Unit: A
Max. Discharging Current	The maximum battery discharging current set by the inverter.** Unit: A
Battery Communication Protocol No.	Set only when the Battery Type is set to <b>Lithium Battery</b> . Set to 0 for MBL160 or pylontech-compatible third-party lithium batteries. Set to 1 for MGL060.



\*When set to No Battery, battery parameters can still be configured but will not take effect.



\*\*SUNGROW is not liable for any loss caused by violating general safety practices, safety standards, or safety precautions specified in this manual.

### Energy Management Mode

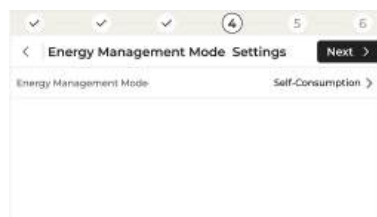

Parameter	Description
Self-Consumption	<p>Default working mode for most scenarios.<sup>1</sup> PV generation usage priority:</p> <ul style="list-style-type: none"> <li>• Load &gt; Battery Charge &gt; Feed into grid.</li> <li>• Load supply priority: PV Generation &gt; Battery Discharge &gt; Energy Purchasing.</li> </ul>
Compulsory Mode	<p>Primarily used by maintenance personnel, this mode allows manual setting of charging/discharging power to force battery charging or discharging for maintenance purposes.</p> <ul style="list-style-type: none"> <li>• Charging/Discharging Command:                             <ul style="list-style-type: none"> <li>- Stop: Stop charging or discharging.</li> <li>- Charge: Start to charge the battery with the set power.</li> <li>- Discharge: Start to discharge the battery with the set power.</li> </ul> </li> </ul> <p>Charging/Discharging Power: Set a value within the specified range.</p> <div style="border: 1px solid black; padding: 5px; margin-top: 10px;"> <p><b>i</b> Compulsory Mode requires the DC Switch to be turned off in advance.</p> </div>
Emergency Guard	<p>Used to reserve backup power for emergencies; requires setting the Emergency Reserved SOC.<sup>2</sup></p>

**1.** In Self-Consumption mode, you can also set Charging/Discharging Period and Charging/Discharging Power under Battery Parameters. The settings are only effective for on-grid running.

After initialization, go to  > Battery Parameters to configure these settings. During the charging period, PV usage priority: Battery Charge > Load > Feed-in. The battery does not discharge during this period.

**2.** In Emergency Guard mode, the system ensures loads are supplied while PV and grid power charge the battery up to the Emergency Reserved SOC. Once reached, the grid draw stops, but excess PV power can continue charging the battery. While grid-connected, the battery does not discharge and maintains battery SOC ≥ Emergency Reserved SOC for off-grid use.

### Multi-Function Port

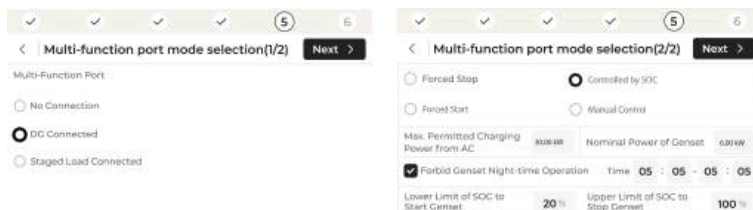

Options for multi-function port parameter settings:

- No Connection: Apply when no device is connected to the inverter's multi-function port (sink screen printing: GEN).
- DG Connected: Apply when a diesel generator is connected to the inverter's multi-function port.



After setting the genset parameters, further adjustments can be done via "Genset Parameters".

Parameter	Description
Genset Start/Stop Control	<ul style="list-style-type: none"> <li>- Forced Stop: When set to Forced Stop, the inverter disconnects the DO relay, and the genset stops running.</li> <li>- Forced Start: When set to Forced Start, the inverter closes the DO relay after grid failure, and the genset starts running.</li> <li>- Controlled by SOC: When set to Controlled by SOC mode, genset start/stop is controlled by battery SOC. <ul style="list-style-type: none"> <li>• Lower Limit of SOC to Start Genset: The lower SOC threshold to start the genset. When battery SOC &lt; this limit, the DO relay closes and the genset starts running. The battery stops discharging. The genset</li> </ul> </li> </ul>

Parameter	Description
	<p>will prioritize supplying power to loads and charge the battery with any surplus power until SOC reaches Upper Limit of SOC to Stop Genset, then the DO relay opens and the genset stops.</p> <ul style="list-style-type: none"> <li>• Upper Limit of SOC to Stop Genset: The upper SOC threshold to stop the genset. When battery SOC <math>\geq</math> this limit, the DO relay opens and the genset stops running. Loads will be powered by PV first; if PV power is insufficient, the battery will discharge to supply power to the loads.</li> <li>- Manual Control: When set to Manual Control, genset start/stop is not controlled by the inverter but by an external switch on the genset.</li> </ul>
Max. Permitted Charging Power from AC	<p>Maximum genset charging power for the battery. After genset starts, PV power is used only to charge the battery, not to supply loads. If PV power is insufficient, surplus genset power charges the battery, but charging power does not exceed this value.</p> <p>Unit: kW</p>
Nominal Power of Genset	<p>Rated power of the genset.</p> <p>Unit: kW</p>
Forbid Genset Night-time Operation	<p>Period when genset is prohibited from running. Enable to set the time window during which the genset will not operate.</p>

- Staged Load Connected: Apply when a load is connected to the inverter's multi-function port.



Only standalone systems support the Staged Load Connected mode.

- Immediate Load Disconnection
  - When the grid is normal, the load on the multi-function port can operate normally.
  - After grid power failure, the load on the multi-function port stops running.
- Load Control by SOC/Voltage



- When the grid is normal, the load on the multi-function port can operate normally.
- Using Staged Load Startup SOC 80% and Staged Load Breaking SOC 40% as an example, when the grid fails:
  - • If the battery SOC is  $\geq 80\%$ , the load on the multi-function port can operate normally until the SOC drops to 40%. At that point, the multi-function port stops power output and the load stops running.
  - If the battery SOC is  $< 80\%$ , the load on the multi-function port stops running immediately.
- Load Control by Timer

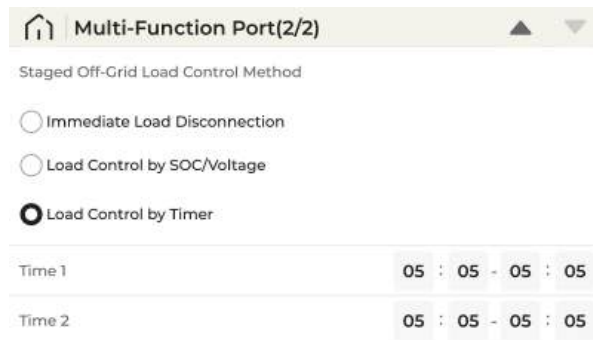

- When the grid is normal, the load on the multi-function port can operate normally.
- After grid power failure,
  - within the set time period, the load on the multi-function port can operate normally.
  - outside the set time period, the load on the multi-function port stops running.

### Confirm the Information

Review settings and click "Complete" to finalize initialization.

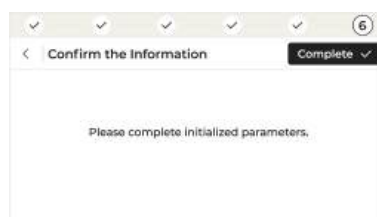



Illustrations are for reference only; actual screens may vary depending on the scenario.

## 8.2 Home Screen Information

When the LCD screen is activated, it will display the home screen by default.

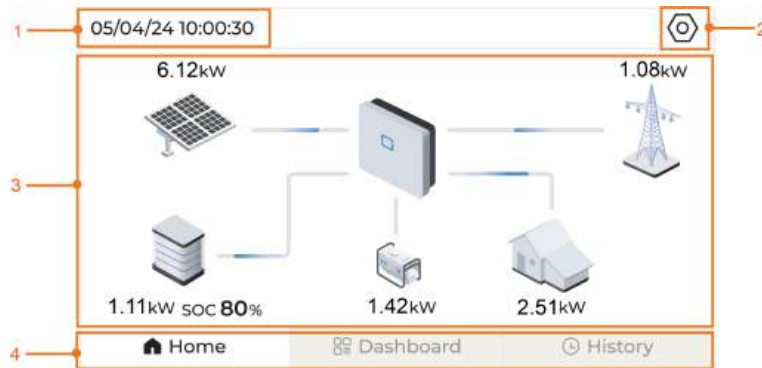

No.	Name	Description
1	Date & time	Shows system date and time.
2	Settings	For parameter configuration.
3	Power Flow Diagram	Displays PV generation power, feed-in power, etc. Animated blue lines between icons show energy flow direction. Tap icons to view detailed device data
4	Navigation Bar	Includes Home, Dashboard, and History menus.



- The generator icon will appear only if a generator is connected.
- The icon indicates a fault. The icon indicates an alarm. Tap the icon to view details.

After tapping , enter the initial installer/user password to log in to the corresponding account. The installer account must perform initialization settings. The initial passwords are as follows.

- Installer password: 1997
- User password: 2025 (default, changeable after first login)



To restore the factory default password, press and hold both ESC and ENTER for 5 seconds until the operation status indicator flashes rapidly 4 times.

When multiple inverters are set in parallel, the inverter connected to the CT is the master unit. The top of the LCD screen will display "Master".

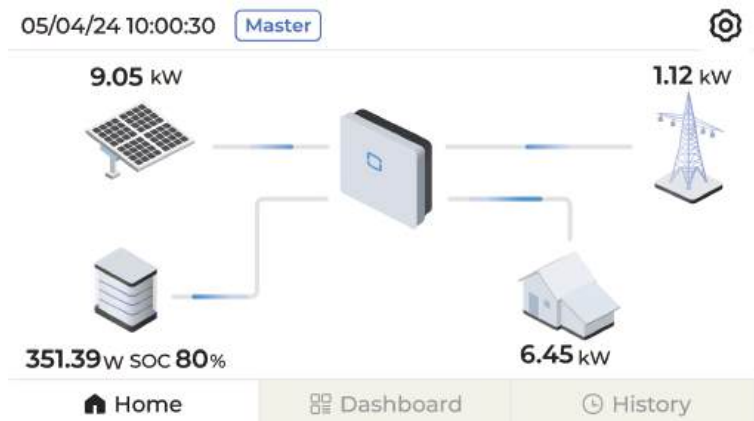

Master unit settings: set Master-Slave Settings to 0; set Total Number of Master and Slaves to the total number of parallel inverters; set Battery Parallel Connection For Multi-Inverter System and related parameters.

Other inverters are slaves. On slave units, set Master-Slave Settings to 1. After being set as a slave, the existing parameter settings on the slave unit will be invalid, and the master unit's settings will prevail. For more information, please see [8.3.8 Multi-machine Parameters](#).

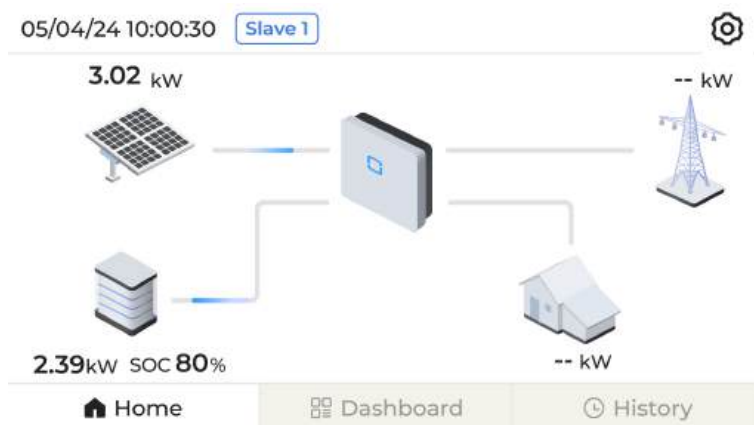

## 8.3 Settings

### 8.3.1 Battery Parameters



Parameter	Description
Battery Type	Refer to <a href="#">8.1 Initialization Settings</a> .
Battery Capacity Setting	Refer to <a href="#">8.1 Initialization Settings</a> .
Max. Charging Current	Refer to <a href="#">8.1 Initialization Settings</a> .
Max. Discharging Current	Refer to <a href="#">8.1 Initialization Settings</a> .
Battery Communication Protocol No	Refer to <a href="#">8.1 Initialization Settings</a> .
Battery Charge/Discharge Settings*	<p>Set according to actual requirements.</p> <ul style="list-style-type: none"> <li>• Charge: When checked, charge settings take effect; when unchecked, discharge settings apply.</li> <li>• Time: Time setting, range: 00:00–23:59</li> <li>• Power: Power setting</li> <li>• Batt: Battery SOC target value</li> </ul>
Select Date*	<ul style="list-style-type: none"> <li>• Mon</li> <li>• Tue</li> <li>• Wed</li> <li>• Thu</li> <li>• Fri</li> <li>• Sat</li> <li>• Sun</li> </ul>



All unchecked by default.

\*Select days for which the charge/discharge settings will apply. Example:

Time	Start	End	Power	Batt
<input checked="" type="checkbox"/>	01:00	04:00	6000 W	60 %
<input checked="" type="checkbox"/>	04:00	08:00	6000 W	60 %
<input checked="" type="checkbox"/>	08:00	12:00	6000 W	60 %
<input checked="" type="checkbox"/>	12:00	16:00	6000 W	60 %
<input type="checkbox"/>	16:00	20:00	2000 W	40 %
<input type="checkbox"/>	20:00	01:00	2000 W	40 %

Select Date:  Mon  Tue  Wed  Thu  Fri  Sat  Sun



If Monday is selected, the charge/discharge settings will take effect only on Monday; settings will not apply on other unselected days.

- 01:00–04:00, 04:00–08:00, 08:00–12:00, 12:00–16:00: When battery SOC is below 60%, the system charges the battery at maximum charging capacity (max. 6000W) until it reaches 60%. The system does not discharge during the charging time period.
- 16:00–20:00, 20:00–01:00: When battery SOC is above 40%, the inverter discharges the battery at maximum discharging capacity (max. 2000W) until it reaches 40%. When the battery SOC is below 40%, discharge does not take effect.



When a start time is set, the end time of the previous time slot will be updated accordingly.

When an end time is set, the start time of the next time slot will be updated accordingly.



The end time of a recommended time period must be later than the start time. Only one time period is allowed to have an end time earlier than the start time, in which case it indicates that the time period spans across 00:00.

- If the configured dates are non-consecutive (with day intervals), the system will execute until 23:59 on the specified date. All time period settings after 00:00 will not take effect.
- If the configured dates are consecutive, the system will execute until 23:59 on the last day of the consecutive dates. All time period settings after 00:00 will not take effect.

### 8.3.2 Multi-Function Port Parameters

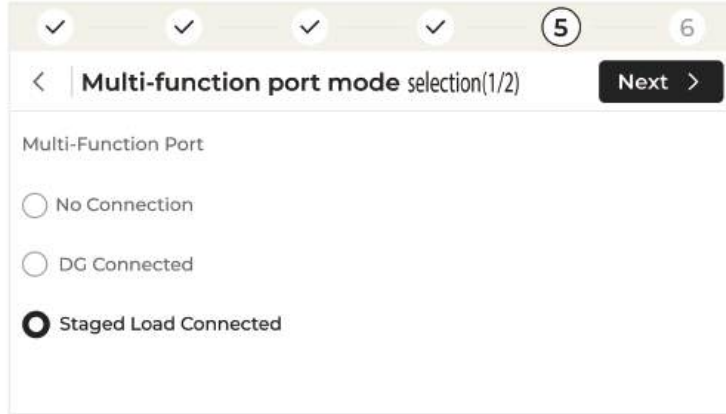

Parameter	Mode
Multi-Function Port	Refer to <a href="#">8.1 Initialization Settings</a> .

### 8.3.3 Power Regulation Parameter

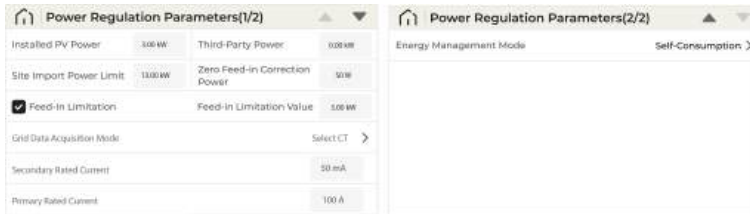

Parameter	Description
Installed PV Power	Refer to <a href="#">8.1 Initialization Settings</a> .
Site Import Power Limit	Refer to <a href="#">8.1 Initialization Settings</a> .
Third-Party Power	Refer to <a href="#">8.1 Initialization Settings</a> .
Zero Feed-in Correction Power	When the Feed-in Limitation Value is set to 0, this parameter defines the maximum grid power draw allowed. Required for strict zero-feed-in scenarios.
Feed-in Limitation Feed-in Limitation Value	Refer to <a href="#">8.1 Initialization Settings</a> .
Grid Data Acquisition Mode	Refer to <a href="#">8.1 Initialization Settings</a> .
Energy Management Mode	Refer to <a href="#">8.1 Initialization Settings</a> .



If a CT or meter is connected in a whole-home backup scenario, it is recommended to set the mode to Select CT or Select Meter, according to the actual requirements.

For single inverter systems with no generator connected to the multi-function port, if the DO port is connected to an intelligent load (e.g., SG Ready load) and requires control, set the Load Control to Scheduled Mode, Intelligent Mode, or Switch Mode.

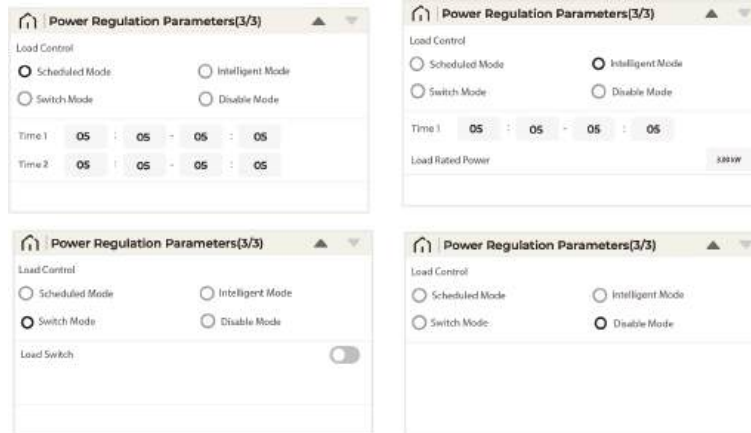

Mode	Description
Scheduled Mode	Activate load during preset time windows.
Intelligent Mode	Activate load when power reaches Load Rated Power value within set time windows.
Switch Mode	Manually control load via Load Switch.
Disable Mode	Disable DO port intelligent load control.

### 8.3.4 Genset Parameters

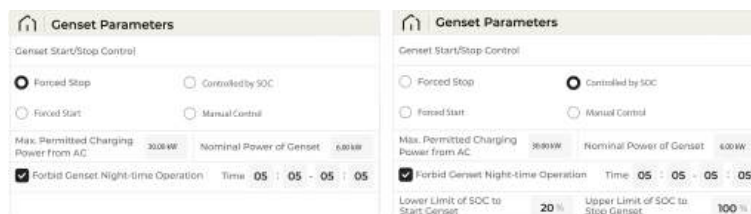

Parameter	Description
Genset Start/Stop Control	Refer to <a href="#">8.1 Initialization Settings</a> .
Max. Permitted Charging Power from AC	Refer to <a href="#">8.1 Initialization Settings</a> .

Parameter	Description
Nominal Power of Genset	Refer to <a href="#">8.1 Initialization Settings</a> .
Forbid Genset Night-time Operation	Refer to <a href="#">8.1 Initialization Settings</a> .

### 8.3.5 System Parameters



Parameter	Description
Date&Time	Refer to <a href="#">8.1 Initialization Settings</a> .
24-Hour	Refer to <a href="#">8.1 Initialization Settings</a> .
Brightness adjustment	Adjust as needed.
Password Settings	Used to change the user password. The old password is required. <div style="border: 1px solid gray; padding: 5px; margin-top: 10px;"> <p> To restore the factory default password, press and hold both ESC and ENTER for 5 seconds until the operation status indicator flashes rapidly 4 times.</p> </div>
Low Noise Mode	Turn off the fan.
Boot/Shutdown	Manual power on/off via button.
Factory Reset	Restore factory settings.
Country	Refer to <a href="#">8.1 Initialization Settings</a> .

### 8.3.6 Off-grid Parameters

Off-grid Parameters	
Backup Voltage	220.0 V
Minimum output voltage during off-grid operation	70.0 %
<input checked="" type="checkbox"/> Backup Mode	Reserved Battery SOC for Off-Grid 20 %
<input checked="" type="checkbox"/> Automatic Recharge to Reserved Battery SOC for Off-grid	
<input type="checkbox"/> Backup N-line to Ground Detection	
Offgrid Emergency Charging	<input checked="" type="checkbox"/>
Target SOC of Offgrid Emergency Charging	20 %

Parameter	Description
Backup Voltage	Set according to grid standards. Default: 230 V. Unit: V
Minimum output voltage during off-grid operation	Off-grid voltage lower limit = Minimum output voltage during off-grid operation% U, where U = off-grid voltage setpoint (default is the voltage value corresponding to the country code). Default: 70%. Unit: % Configurable range: 40%–100%
Backup Mode	Select as needed. <ul style="list-style-type: none"> <li><input checked="" type="checkbox"/>: Enable Backup Port. After grid failure, the system switches to off-grid mode to supply power to loads connected to the backup port.</li> <li><input type="checkbox"/>: Do not enable Backup Port. After grid failure, loads connected to the backup port will lose power.</li> </ul>
Reserved Battery SOC for Off-Grid	Set based on the power and expected runtime of the loads connected to the backup port, and the system's battery capacity. During on-grid operation, the battery stops discharging when SOC reaches this value, and only discharges further when the system is in off-grid mode to supply loads connected to the backup port. Unit: % <div style="border: 1px solid gray; padding: 5px; margin-top: 10px;"> <p> This parameter takes effect only when Energy Management Mode is set to Self-consumption and the system is on-grid running.</p> </div>
Automatic Recharge to Reserved Battery SOC for Off-grid	If enabled, the system draws grid power to recharge the battery to Reserved Battery SOC for Off-Grid when the SOC falls below this threshold in on-grid mode.

Parameter	Description
Backup N-line to Ground Detection	<ul style="list-style-type: none"> <li><input checked="" type="checkbox"/>: Enable Backup N-line to Ground Detection in Backup mode.</li> <li><input type="checkbox"/>: Disable Backup N-line to Ground Detection in Backup mode. Disable if no load is connected to the backup port (to avoid fault code 106).</li> </ul>
Offgrid Emergency Charging Target SOC of Offgrid Emergency Charging	When enabled, during off-grid operation, to ensure stable system operation and load supply, PV power will first charge the battery until it reaches Target SOC of Offgrid Emergency Charging. During this process, PV will not supply power to loads.*

**i** \*Target SOC of Offgrid Emergency Charging: During off-grid operation, if the battery SOC falls below (Target SOC of Offgrid Emergency Charging – 3%), Offgrid Emergency Charging is triggered, sourcing power from PV. During this charging process, no loads are powered. Charging continues until (Target SOC of Offgrid Emergency Charging + 5%) is reached, then load supply resumes in backup mode. Configurable range: 0–100%.

### 8.3.7 Operation Parameters

**i** Configurable by installer only. SUNGROW is not liable for damages caused by unauthorized user modifications.

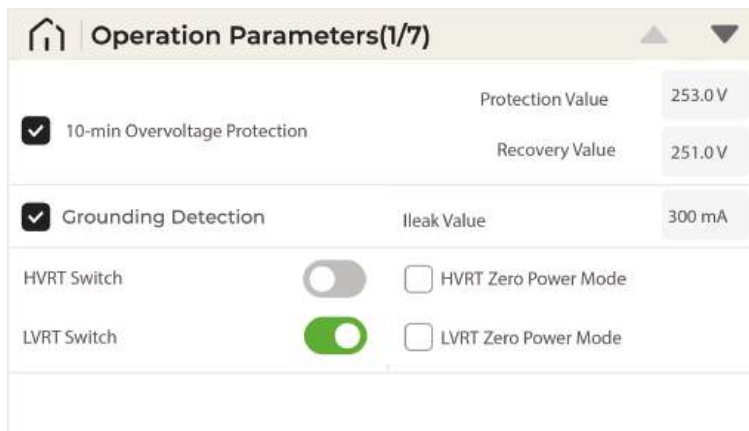

Parameter	Description
10-min Overvoltage Protection Protection Value Recovery Value	This parameter typically does not require modification, unless required by new guidelines from the grid operator. In the event of grid fluctuations, where the

Parameter	Description
	grid overvoltage fault (fault code: 14) is frequently reported by the inverter, you can properly increase the protection threshold with approval from the grid operator.
Grounding Detection	In the event of a false alarm or if PV grounding faults (fault code: 106) are frequently reported due to a low threshold setting, you can disable Grounding Detection or increase the PV Voltage Drop Threshold.
Ileak Value	ILEAK protection value.
HVRT Switch	This parameter typically does not require modification, unless required by new guidelines from the grid operator.
HVRT Zero Power Mode	This parameter typically does not require modification, unless required by new guidelines from the grid operator.
LVRT Switch	This parameter typically does not require modification, unless required by new guidelines from the grid operator.
LVRT Zero Power Mode	This parameter typically does not require modification, unless required by new guidelines from the grid operator.

The screenshot displays the 'Operation Parameters(2/7)' screen with the following settings:

- Power Reduction at Overfrequency
- Overfrequency Derating Curve:  A  B  C
- Power Recovery Time Delay: 4.0 s
- Overfrequency Derating Delay Time: 0.00 s
- Power Derating Gradient: 6000 %/min
- Power Recovery Gradient: 10 %/min
- Recovery Frequency: 50.48 Hz
- F1 50.50 F2 52.00 F3 52.00 Hz
- P1 100.0 P2 25.0 P3 25.0 %

Parameter	Description
Power Reduction at Overfrequency	<p>Setting switch for over-frequency derating function</p> <p>When the function is enabled, and the grid frequency exceeds the derating threshold, the inverter performs active derating at a specific slope.</p> <ul style="list-style-type: none"> <li>• <math>F1 \leq F2 \leq F3</math> <ul style="list-style-type: none"> <li>- F1(Hz): Active derating start point</li> <li>- F2(Hz): Active derating point 2</li> <li>- F3(Hz): Active derating end point</li> </ul> </li> <li>• <math>P1 \geq P2 \geq P3</math> <ul style="list-style-type: none"> <li>- P1(%): Active power corresponding to the uprating start point</li> <li>- P2(%): Active power corresponding to the uprating point 2</li> <li>- P3(%): Active power corresponding to the uprating end point</li> </ul> </li> </ul>
Overfrequency Derating Curve	<p>Curve that shows active power changing with frequency. Three different curves are provided. Select one according to local grid standards.</p> <ul style="list-style-type: none"> <li>• Curve A: The active power of the inverter changes with the frequency in real time after over frequency derating occurs.</li> <li>• Curve B: After overfrequency derating occurs, the active power of the inverter does not recover until the frequency reaches the overfrequency derating recovery stop point.</li> <li>• Curve C: It is reserved and consistent with Curve A currently</li> </ul>
Power Recovery Time Delay	<p>Waiting time from the moment where the frequency is lower than or equal to the Recovery Frequency, to the moment at which the active power begins to recover.</p>

Parameter	Description
Power Derating Gradient (%/min)	The decline rate of active power when overfrequency derating occurs
Overfrequency Derating Delay Time	The response time after over frequency derating occurs.
Power Recovery Gradient (%/min)	The recovery rate of active power during Power Recovery Time Delay
Recovery Frequency (Hz)	The point at which the frequency recovers after active derating.

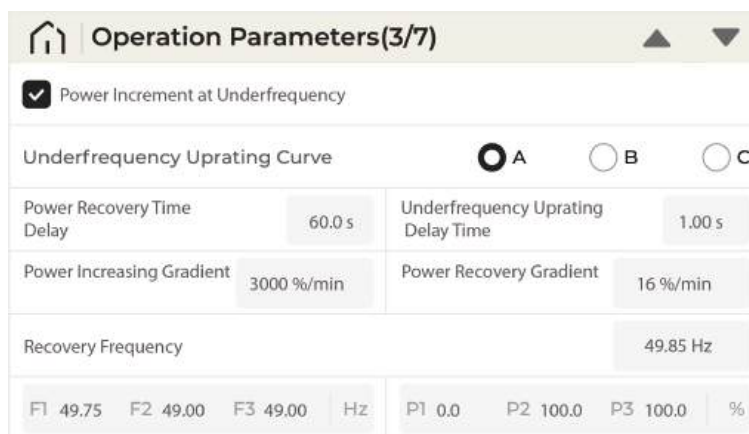

Parameter	Description
Power Increment at Underfrequency	<p>Switching of the grid frequency below a preset value to increase active power</p> <p>When the function is enabled, and the grid frequency is lower than the uprating threshold, the inverter performs active uprating at a specific slope.</p> <ul style="list-style-type: none"> <li>• <math>F1 \geq F2 \geq F3</math> <ul style="list-style-type: none"> <li>- F1(Hz): Underfrequency uprating start point</li> <li>- F2(Hz): Underfrequency uprating point 2</li> <li>- F3(Hz): Underfrequency uprating end point</li> </ul> </li> </ul> <p><math>P1 \leq P2 \leq P3</math></p> <ul style="list-style-type: none"> <li>• P1(%): Active power corresponding to the uprating start point</li> <li>• P2(%): Active power corresponding to the uprating point 2</li> </ul>

Parameter	Description
	<ul style="list-style-type: none"> <li>P3(%): Active power corresponding to the uprating end point</li> </ul>
Underfrequency Uprating Curve	<p>Curve that shows active power changing with frequency. Three different curves are provided. Select one according to local grid standards.</p> <p>Curve A: The active power of the inverter changes with the frequency in real time after over frequency derating occurs.</p> <p>Curve B: After overfrequency derating occurs, the active power of the inverter does not recover until the frequency reaches the overfrequency derating recovery stop point.</p> <p>Curve C: It is reserved and consistent with Curve A currently.</p>
Power Recovery Time Delay (s)	Waiting time from the moment at which the underfrequency uprating occurs to the moment at which the active power begins to recover.
Power Increasing Gradient(%/min)	The increasing rate of active power after underfrequency uprating occurs.
Underfrequency Uprating Delay Time (s)	Response time after under frequency uprating occurs.
Power Recovery Gradient (%/min)	The recovery rate of active power during Power Recovery Time Delay
Recovery Frequency (Hz)	The point at which the frequency recovers after active derating.



Operation Parameters(4/7)

Protection Level **3**

Overvoltage Recovery Value **251.0 V**

Level	Value (V)	Time (s)
Level 1	253.0 V	40.00 s
Level 2	264.5 V	2.00 s
Level 3	276.0 V	0.16 s

Parameter	Description
Protection level	The level of protection of overvoltage/ undervoltage and overfrequency/ underfrequency. range: 1-5
Overvoltage Recovery Value (V)	Overvoltage protection recovery value
Overvoltage Level-N Protection(V) (N: 1-5)	$(1.0V_n + 0.2V) \sim 1.4V_n$ $V_n$ : Rated voltage
Overvoltage Level-N Tripping Time (s) (N: 1-5)	50ms - 14400000ms

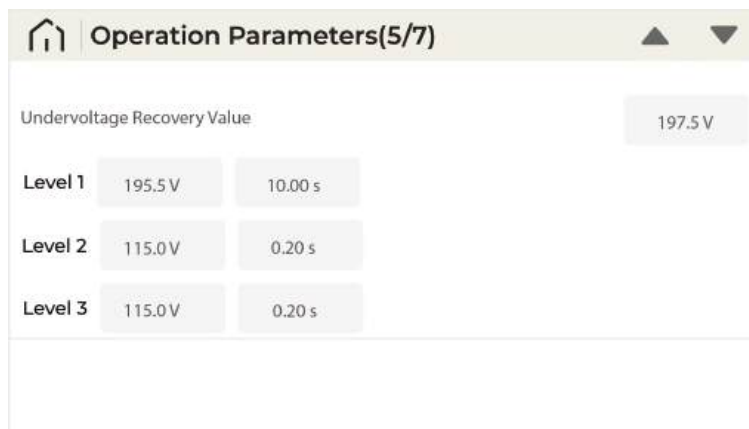

Operation Parameters(5/7)

Undervoltage Recovery Value **197.5 V**

Level	Value (V)	Time (s)
Level 1	195.5 V	10.00 s
Level 2	115.0 V	0.20 s
Level 3	115.0 V	0.20 s

Parameter	Description
Undervoltage Recovery Value (V)	Undervoltage protection recovery value
Undervoltage Level-N Protection Value (V) (N: 1-5)	Waiting time before tripping if Protection Value is reached. 50ms - 14400000ms

Parameter	Description
Undervoltage Level-N Tripping Time (s) (N: 1-5)	The frequency at which grid overfrequency fault is cleared.

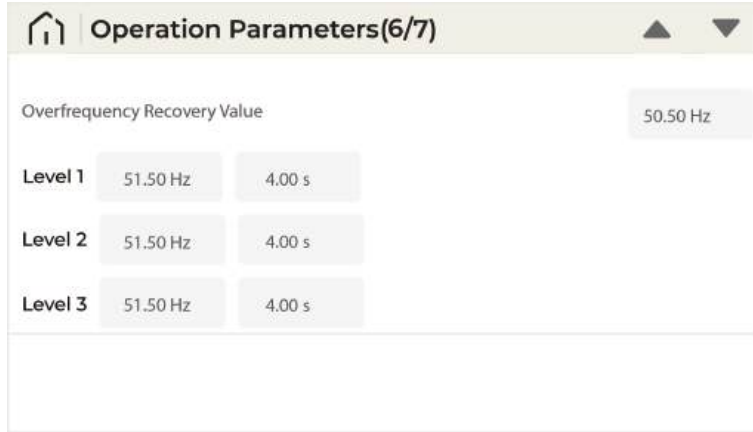

Parameter	Description
Overfrequency Recovery Value(Hz)	The frequency at which grid overfrequency fault is cleared.
Overfrequency Level-N Protection Value (Hz) (N: 1-5)	50Hz grid: 50.04Hz - 55.00Hz 60Hz grid: 60.04Hz - 66.00Hz
Overfrequency Level-N Tripping Time (s) (N: 1-5)	50ms - 14400000ms

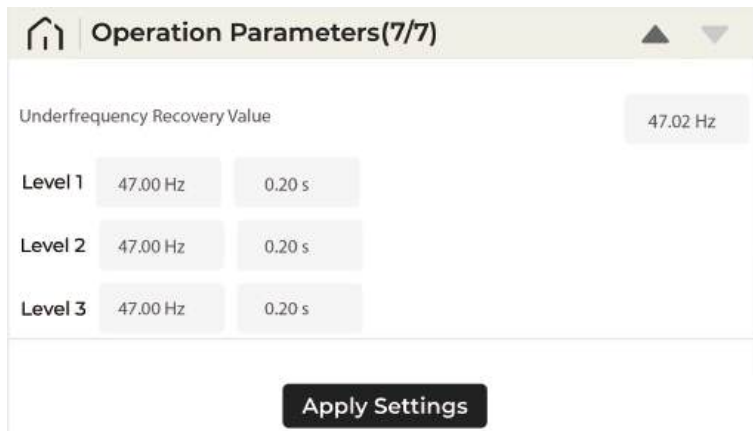

Parameter	Description
Underfrequency Recovery Value (Hz)	The frequency at which grid underfrequency fault is cleared

Parameter	Description
Underfrequency Level-N Protection Value (Hz) (N: 1-5)	50Hz grid: 45.00Hz - 49.96Hz 60Hz grid: 55.00Hz - 59.96Hz
Underfrequency Level-N Tripping Time (s) (N: 1-5)	50ms - 14400000ms

### 8.3.8 Multi-machine Parameters



Configurable by installer only. SUNGROW is not liable for damages caused by unauthorized user modifications.



Master-slave settings must match the actual system configuration.

The Master-Slave Operation Mode is mainly used when multiple inverters are connected in parallel. If enabled, the master inverter needs to set all 4 parameters below. The slave inverter only needs to set Master-Slave Operation Mode and Master-Slave Settings.

Parameter	Description
Master-Slave Operation Mode	<ul style="list-style-type: none"> <li>• Enable: Enable master-slave mode.</li> <li>• Disable: Disable master-slave mode.</li> </ul>
Master-Slave Settings	<ul style="list-style-type: none"> <li>• 0: Master inverter.</li> <li>• 1: Slave inverter.</li> </ul>
Total Number of Master and Slaves	Number of master and slave inverters
Battery Parallel Connection For Multi-Inverter System	<ul style="list-style-type: none"> <li>• Enabled (Default): Applicable for scenarios where the battery terminals on the inverter side are connected in parallel to the battery, and the loads</li> </ul>

Parameter	Description
	<p>are centrally connected to the off-grid output port.</p> <ul style="list-style-type: none"> <li>Disabled: Applies when the battery terminals on the inverter side are connected independently to the battery. This mode is only supported in 2-unit parallel inverter systems of the MG5/6RL series. It supports both One Backup Port one Load (each inverter's backup port connects to an independent load) and All Backup Ports one Load (all backup ports are paralleled and connect to the same load).</li> </ul> 

# 9 iSolarCloud App

## 9.1 About iSolarCloud

The iSolarCloud App is a mobile application used for power plant management. The App provides plant operation analysis service and enables intelligent mobile O&M. It is designed with functions such as plant operation data display, rapid plant access, parameter setting, quick fault location and notification, and power yield and revenue analysis. With iSolarCloud, convenient and efficient end-to-end plant O&M is allowed.

### Connection Methods

Users can log in to the App via remote connection or local access for plant monitoring.

#### Login by Establishing a Direct Connection (Local)

Establish communication between the mobile phone and the WiFi wireless communication module or the inverter's built-in Bluetooth module to enable mobile maintenance of the inverter. After logging into the App, users can check the information about and set parameters for the inverter.



Direct Login (Local)



Login via Bluetooth connection is applicable only for SUNGROW inverters with built-in Bluetooth modules. Please consult your retailer/installer about whether the inverter is equipped with a Bluetooth module.

#### Login with an Account (Remote)

Establish communication between the communication module and the home router or base station to enable data exchange between the inverter and the cloud server. After logging

into the App, users can check the inverter data or send commands to control the inverter on the App.

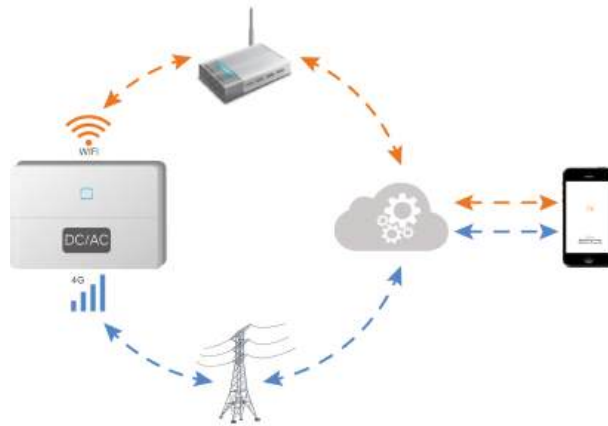

Login Via Account and Password (Remote)

## 9.2 Install iSolarCloud

### Prerequisite

This section introduces how to download and install the iSolarCloud App.

### Procedure

**Step 1** Search for **iSolarCloud** in App Store, Google Play or other App stores, or scan the QR code below with a mobile phone and download the App by following the onscreen instructions.



**Step 2** Tap the downloaded installation package and follow the onscreen instructions to complete the installation. The icon of iSolarCloud will then appear on the screen.



--End

### 9.3 User Roles

After logging into the iSolarCloud App with different roles, users will have varying levels of access to device operations. The default accounts and passwords corresponding to different user roles can be found in [iSolarCloud App User Manual Device Commissioning \(V2.1.6.20250218or Later\)](#) > **Device Connection** > **Device Connection via WLAN** > **Identity Verification**.

For account security purposes, please refer to the **Identity Verification** section to change your password promptly after logging into the iSolarCloud App.

### 9.4 Device Commissioning

For device commissioning operations, please refer to the **Device Commissioning** in the [iSolarCloud App User Manual](#). Alternatively, you can scan the QR code below to access the **Device Commissioning** section of the manual.



# 10 System Decommissioning/Shutdown Procedure

## 10.1 Decommissioning the Inverter

### 10.1.1 Disconnecting the Inverter

#### CAUTION

##### **Danger of burns!**

**Even if the inverter is shut down, it may still be hot and cause burns. Wear protective gloves before operating the inverter after it cools down.**

For maintenance or other service work, the inverter must be switched off. Proceed as follows to disconnect the inverter. Lethal voltages or damage to the inverter will follow if otherwise.

- Step 1** Disconnect the external AC circuit breaker and prevent it from inadvertent reconnection.
  - Step 2** Rotate the DC switch to the "OFF" position for disconnecting all of the PV string inputs.
  - Step 3** Turn off the DC breaker between the inverter and the battery, then power down the battery.
  - Step 4** Wait about 10 minutes until the capacitors inside the inverter completely discharge.
  - Step 5** Ensure that the DC cable is current-free with a current clamp.
- End

### 10.1.2 Dismantling the Inverter

#### Prerequisite

#### CAUTION

##### **Risk of burn injuries and electric shock!**

**After the inverter is powered off for 10 minutes, measure the voltage and current with professional instrument. Only when there is no voltage nor current can operators who wear protective equipment operate and maintain the inverter.**

Before dismantling the inverter, disconnect both AC and DC connections.

If there are more than two layers of inverter DC terminals, dismantle the outer DC connectors before dismantling the inner ones.



If the original packing materials are available, put the inverter inside them and then seal them using adhesive tape. If the original packing materials are not available, put the inverter inside a cardboard box suitable for the weight and size of this inverter and seal it properly.

- Step 1** Refer to [6 Electrical Connection](#) for the inverter disconnection of all cables in reverse steps.

- Step 2** Dismantle the inverter referring to [5 Mechanical Mounting](#) in reverse steps.
- Step 3** If necessary, remove the wall-mounting bracket from the wall.
- Step 4** If the inverter will be reinstalled in the future, please refer to [4.3 Inverter Storage](#) for a proper conservation.
- End

### 10.1.3 Disposal of Inverter

Users take the responsibility for the disposal of the inverter.

#### **WARNING**

**Please scrap the inverter in accordance with relevant local regulations and standards to avoid property losses or casualties.**

#### **NOTICE**

**Some parts of the inverter may cause environmental pollution. Please dispose of them in accordance with the disposal regulations for electronic waste applicable at the installation site.**

## 10.2 Decommissioning the Battery

### Prerequisite

Decommission the battery in the system after the inverter is decommissioned. Proceed as follows to decommission a Li-ion battery.

- Step 1** Disconnect the DC circuit breaker between the battery and the inverter.
- Step 2** Disconnect the communication cable between the battery and the inverter.
- Step 3** Wait for about 1 minute and then use the multimeter to measure the port voltage of the battery.
- Step 4** If the battery port voltage is zero, disconnect the power cables from the battery module.
- End



For disposal of this product, please call the phone number listed in the warranty booklet provided at the time of purchase.

# 11 Troubleshooting and Maintenance

## 11.1 Troubleshooting

When an alarm occurs, the alarm information can be viewed through the App.

Alarm ID and corrective measures are as follows:

Alarm ID	Alarm Name	Corrective Measures
002, 003, 014, 015	Grid Overvoltage	Generally, the inverter will be reconnected to the grid after the grid returns to normal. If the fault occurs repeatedly: <ol style="list-style-type: none"><li>1. Measure the actual grid voltage, and contact the local electric power company for solutions if the grid voltage is higher than the set value.</li><li>2. Check whether the protection parameters are appropriately set via the App or the LCD. Modify the overvoltage protection values with the consent of the local electric power operator.</li><li>3. If the fault still exists, contact SUNGROW.</li></ol>
004, 005	Grid Undervoltage	Generally, the inverter will be reconnected to the grid after the grid recovers. If the alarm occurs frequently: <ol style="list-style-type: none"><li>1. Measure the grid voltage, and contact the local utility grid company for solutions if the grid voltage is below the specified value.</li><li>2. Check, through the App, whether the protection parameters are appropriately set.</li><li>3. Check whether the AC cable is firmly in place.</li><li>4. If the alarm persists, contact SUNGROW.</li></ol>
008	Grid Overfrequency	Generally, the inverter will be reconnected to the grid after the grid recovers. If the alarm occurs frequently: <ol style="list-style-type: none"><li>1. Measure the grid frequency, and contact the local utility grid company for solutions if the grid frequency is beyond the specified range.</li><li>2. Check, through the App, whether the protection parameters are appropriately set.</li><li>3. If the alarm persists, contact SUNGROW.</li></ol>
009	Grid Underfrequency	Generally, the inverter will be reconnected to the grid after the grid recovers. If the alarm occurs frequently: <ol style="list-style-type: none"><li>1. Measure the grid frequency, and contact the local utility grid company for solutions if the grid frequency is beyond the specified range.</li><li>2. Check, through the App, whether the protection parameters are appropriately set.</li><li>3. If the alarm persists, contact SUNGROW.</li></ol>

Alarm ID	Alarm Name	Corrective Measures
010	Grid Power Outage	<p>Generally, the inverter will be reconnected to the grid after the grid recovers. If the alarm occurs frequently:</p> <ol style="list-style-type: none"> <li>1. Check whether the grid supplies power reliably.</li> <li>2. Check whether the AC cable is firmly in place.</li> <li>3. Check whether the AC cable is correctly connected (whether the live wire and the N wire are in correct place).</li> <li>4. Check whether the AC switch or circuit breaker is disconnected.</li> <li>5. If the alarm persists, contact SUNGROW.</li> </ol>
012	Excessive Leakage Current	<ol style="list-style-type: none"> <li>1. The alarm can be caused by poor sunlight or damp environment, and the inverter will be reconnected to the grid after the environment is improved.</li> <li>2. If the environment is normal, check whether the AC and DC cables are well insulated.</li> <li>3. If the alarm persists, contact SUNGROW.</li> </ol>
013	Grid Abnormal	<p>Generally, the inverter will be reconnected to the grid after the grid recovers. If the alarm occurs frequently:</p> <ol style="list-style-type: none"> <li>1. Measure the grid frequency, and contact the local utility grid company for solutions if the grid frequency exceeds the specified value.</li> <li>2. If the alarm persists, contact SUNGROW.</li> </ol>
017	Grid Voltage Unbalance	<p>Generally, the inverter will be reconnected to the grid after the grid returns to normal. If the fault occurs repeatedly:</p> <ol style="list-style-type: none"> <li>1. Measure the actual grid voltage. If grid phase voltages differ greatly, contact the electric power company for solutions.</li> <li>2. If the voltage difference between phases is within the permissible range of the local power company, modify the grid voltage imbalance parameter through the App.</li> <li>3. If the fault still exists, contact SUNGROW.</li> </ol>
028, 029, 208	PV Reverse Connection Fault	<ol style="list-style-type: none"> <li>1. Check whether the corresponding string is of reverse polarity. If so, disconnect the DC switch and adjust the polarity when the string current drops below 0.5 A.</li> </ol>

Alarm ID	Alarm Name	Corrective Measures
		<p>2. If the fault still exists, contact SUNGROW.</p> <p>*The code 28, 29, 208 are corresponding to PV1, PV2, PV3 respectively.</p>
037	High Ambient Temperature	<p>Generally, the inverter will resume operation when the internal or module temperature returns to normal. If the fault persists:</p> <ol style="list-style-type: none"> <li>1. Check whether the ambient temperature of the inverter is too high;</li> <li>2. Check whether the inverter is in a well-ventilated place;</li> <li>3. Check whether the inverter is exposed to direct sunlight. Shield it if so;</li> <li>4. Check whether the fan is running properly. Replace the fan if not;</li> <li>5. If the fault still exists, contact SUNGROW.</li> </ol>
039	Low System Insulation Resistance	<p>Wait for the inverter to return to normal. If the fault occurs repeatedly:</p> <ol style="list-style-type: none"> <li>1. Check whether the ISO resistance protection value is excessively high via the app, and ensure that it complies with the local regulations.</li> <li>2. Check the resistance to ground of the string and DC cable. Take corrective measures in case of short circuit or damaged insulation layer.</li> <li>3. If the cable is normal and the fault occurs on rainy days, check it again when the weather turns fine.</li> <li>4. If there are batteries, check whether battery cables are damaged and whether terminals are loose or in poor contact. If so, replace the damaged cable and secure terminals to ensure a reliable connection.</li> <li>5. If the fault still exists, contact SUNGROW.</li> </ol>
106	Grounding Cable Fault	<ol style="list-style-type: none"> <li>1. Check whether the AC cable is correctly connected.</li> <li>2. Check whether the insulation between the ground cable and the live wire is normal.</li> <li>3. If the fault still exists, contact SUNGROW.</li> </ol>
051	Off-grid Load Overpower	<ol style="list-style-type: none"> <li>1. Reduce the power of loads connected at the off-grid port, or remove some loads.</li> <li>2. If the alarm persists, contact SUNGROW.</li> </ol>

Alarm ID	Alarm Name	Corrective Measures
714	BMS Communication Fault	<ol style="list-style-type: none"> <li>1. Check whether the communication cable and the terminals are abnormal. If so, correct them to ensure reliable connection.</li> <li>2. Reconnect the communication cable of the meter.</li> <li>3. If the fault still exists, contact SUNGROW.</li> </ol>
932–935, 937, 939	Battery Alarm	<p>Generally, the battery can automatically recover. In case the alarm persist for a long time:</p> <ol style="list-style-type: none"> <li>1. If the alarm is caused by ambient temperature, such as over temperature alarm or low temperature alarm, take measures to change the ambient temperature, such as improving heat dissipation conditions.</li> <li>2. If the fault persists, contact battery manufacturer.</li> </ol>
703, 711, 712, 715, 732–736, 739, 832– 833, 835– 837	Battery Abnormal	<ol style="list-style-type: none"> <li>1. In case of abnormal battery voltage, check whether the battery power cable connection is abnormal (reverse connection, loose, etc.). If so, connect the battery power cable correctly.</li> <li>2. Check whether the battery real-time voltage is abnormal if the battery power cable is correctly connected. If so, contact the battery manufacturer. If not, contact SUNGROW.</li> <li>3. In case of abnormal battery temperature, take measures to change the ambient temperature, such as improving heat dissipation conditions.</li> <li>4. If the fault persists, contact battery manufacturer.</li> </ol>
502-504, 507, 508, 510, 513, 516–518, 994, 996	System Alarm	<ol style="list-style-type: none"> <li>1. The inverter can continue running.</li> <li>2. Check whether the related wiring and terminal are abnormal, check whether there are any foreign materials or other environmental abnormalities, and take corresponding corrective measures when necessary.</li> <li>3. If the alarm persists, please contact SUNGROW.</li> </ol>
514	Meter Communication Abnormal Alarm	<ol style="list-style-type: none"> <li>1. Check whether the communication cable and the terminals are abnormal. If so, correct them to ensure reliable connection.</li> <li>2. Reconnect the communication cable of the meter.</li> <li>3. If the alarm still exists, contact SUNGROW.</li> </ol>

Alarm ID	Alarm Name	Corrective Measures
006, 007, 011, 019, 021, 025, 040–042, 048–050, 052–054, 056, 064– 067, 100– 102, 105, 107, 113, 117, 200– 205, 300, 303–305, 308–316, 320, 600, 601, 605, 608, 612, 616, 620, 624, 995	System Fault	<ol style="list-style-type: none"> <li>1. Wait for the inverter to return to normal.</li> <li>2. Disconnect the AC and DC switches, and disconnect the battery side switches if there are batteries. Close the AC and DC switches in turn 15 minutes later and restart the system.</li> <li>3. Check the PE connection of the inverter..</li> <li>4. If the fault still exists, contact SUNGROW.</li> </ol>
90	Inverter parallel synchronization signal abnormal.	<ol style="list-style-type: none"> <li>1. Please check if there is an error in the multi-unit mode settings of the master and slave units. One unit should be set to master mode. Verify whether the master-slave quantity matches the actual setup. The remaining units should be set to slave mode. Ensure that the slave IDs are assigned sequentially in order.</li> <li>2. Please check if there are any errors in the parallel communication cables. Verify that the CAN2 H/CAN2 L connections for the COM1 ports between the units are correctly wired.</li> <li>3. Please check if the last unit is properly terminated with the matching terminal resistor. The 120Ω resistor plug should be connected between CAN2 H and CAN2 L.</li> </ol>
939	Low Voltage Alarm	<ol style="list-style-type: none"> <li>1. If the alarm occurs during the charging or discharging process, allow the system to rest for a period and the alarm should clear.</li> <li>2. If the alarm appears after the system has been idle for more than 2 hours, the battery may have been left without charging for an extended period. If the energy storage inverter is capable</li> </ol>

Alarm ID	Alarm Name	Corrective Measures
		<p>of charging the battery, the alarm can be resolved by enabling the forced charging function to charge the battery.</p> <p>3. If none of the above causes apply and the alarm persists, please contact Sungrow customer service</p>
739	Low Voltage Protection	<p>1. If the fault occurs during charging or discharging, allow the system to rest for a period of time and the fault should clear.</p> <p>2. If the fault appears after the system has been idle for more than 2 hours, the battery may have been left without charging for an extended period. Please ensure that the energy storage inverter can charge the battery normally. Restarting the battery will trigger the emergency charging function to charge it.</p> <p>3. If the above causes do not apply and the alarm persists, please contact Sungrow customer service.</p>
038	Relay Self-Test Failure	<p>1. Check the parameter settings to see whether the "N-to-ground detection" and "Grounding monitoring" functions are disabled. Verify on site whether the system is grounded.</p> <p>2. If the system is grounded, check whether the L and N wires on the AC side are reversed.</p> <p>3. If fault 038 occurs in off-grid mode, it may be because the PE terminal of the backup port is not externally connected.</p> <p>4. The relay is welded and cannot close; the unit needs to be replaced.</p> <p>5. If the fault is not caused by the foregoing reasons and persists, the unit needs to be replaced. Export the log files, record the software version, and contact Sungrow Customer Service.</p>
75	Parallel Communication Alarm	<p>1. Check whether the master-slave parallel parameters are correctly set in the multi-unit configuration.</p> <p>2. Check whether the communication cables between the master and slave units are disconnected or abnormal.</p>

Alarm ID	Alarm Name	Corrective Measures
		<ol style="list-style-type: none"> <li>3. Try replacing the communication cable.</li> <li>4. If the fault is not caused by the foregoing reasons and persists, the unit needs to be replaced. Export the log files, record the software version, and contact Sungrow Customer Service.</li> </ol>
329	AC Port Wiring Anomaly Fault	<ol style="list-style-type: none"> <li>1. Check when the fault occurred, whether during installation or during operation.</li> <li>2. Check whether the grid port cables are incorrectly connected to the backup port.</li> <li>3. Check whether power is supplied to the diesel generator port while diesel generator mode is not configured.</li> <li>4. Under "All backup ports one load" configuration, if alarm 329 occurs on a unit when another unit starts in off-grid mode without multi-unit settings being configured, reconfigure the master-slave operating mode.</li> <li>5. If none of the above causes is confirmed and the fault persists, unit replacement is required. Export the log information, record the software version, and contact Sungrow Power Supply customer service.</li> </ol>



Contact the installer if the measures listed in the "Troubleshooting Method" column have been taken but the problem persists. Contact SUNGROW if the installer fails to solve the problem.

## 11.2 Maintenance

### 11.2.1 Maintenance Notices

#### **DANGER**

**Risk of inverter damage or personal injury due to incorrect service!**

- Be sure to use special insulation tools when perform high-voltage operations.
- Before any service work, first disconnect the grid-side AC circuit breaker and check the inverter status. If the inverter indicator is on, please wait until night to disconnect the DC switch. If the inverter indicator is off, directly disconnect the DC switch.
- After the inverter is powered off for 10 minutes, measure the voltage and current with professional instrument. Only when there is no voltage nor current can operators who wear protective equipment operate and maintain the inverter
- Even if the inverter is shut down, it may still be hot and cause burns. Wear protective gloves before operating the inverter after it cools down.
- When maintaining the product, it is strictly prohibited to open the product if there is an odor or smoke or if the product appearance is abnormal. If there is no odor, smoke, or obvious abnormal appearance, repair or restart the inverter according to the alarm corrective measures. Avoid standing directly in front of the inverter during maintenance.

#### **CAUTION**

To prevent misuse or accidents caused by unrelated personnel: Post prominent warning signs or demarcate safety warning areas around the inverter to prevent accidents caused by misuse.

#### **NOTICE**

Restart the inverter only after removing the fault that impairs safety performance. As the inverter contains no component parts that can be maintained, never open the enclosure, or replace any internal components.

To avoid the risk of electric shock, do not perform any other maintenance operations beyond those described in this manual. If necessary, contact your distributor first. If the problem persists, contact SUNGROW. Otherwise, the losses caused is not covered by the warranty.

#### **NOTICE**

Touching the PCB or other static sensitive components may cause damage to the device.

- Do not touch the circuit board unnecessarily.
- Observe the regulations to protect against electrostatic and wear an anti-static wrist strap.

### 11.2.2 Maintenance Notices

The DC switch can be secured with a lock in the OFF position or a certain angle beyond the OFF position.(For countries “AU” and “NZ”)

#### **DANGER**

**Risk of inverter damage or personal injury due to incorrect service!**

- **Be sure to use special insulation tools when perform high-voltage operations.**
- **Before any service work, first disconnect the grid-side AC circuit breaker and check the inverter status. If the inverter indicator is off, please wait until night to disconnect the DC switch. If the inverter indicator is on, directly disconnect the DC switch.**
- **After the inverter is powered off for 10 minutes, measure the voltage and current with professional instrument. Only when there is no voltage nor current can operators who wear protective equipment operate and maintain the inverter**
- **Even if the inverter is shut down, it may still be hot and cause burns. Wear protective gloves before operating the inverter after it cools down.**
- **When maintaining the product, it is strictly prohibited to open the product if there is an odor or smoke or if the product appearance is abnormal. If there is no odor, smoke, or obvious abnormal appearance, repair or restart the inverter according to the alarm corrective measures. Avoid standing directly in front of the inverter during maintenance.**

#### **CAUTION**

**To prevent misuse or accidents caused by unrelated personnel: Post prominent warning signs or demarcate safety warning areas around the inverter to prevent accidents caused by misuse.**

#### **NOTICE**

**Restart the inverter only after removing the fault that impairs safety performance. As the inverter contains no component parts that can be maintained, never open the enclosure, or replace any internal components.**

**To avoid the risk of electric shock, do not perform any other maintenance operations beyond those described in this manual. If necessary, contact your distributor first. If the problem persists, contact SUNGROW. Otherwise, the losses caused is not covered by the warranty.**

#### **NOTICE**

**Touching the PCB or other static sensitive components may cause damage to the device.**

- **Do not touch the circuit board unnecessarily.**
- **Observe the regulations to protect against electrostatic and wear an anti-static wrist strap.**

### 11.2.3 Routine Maintenance

Item	Method	Period
Device clean	Check the temperature and dust of the device. Clean the device enclosure if necessary.	Six months to a year (depending on the dust contents in air)
Electrical connection	Check whether all cable are firmly connected in place. Check whether there is damage to the cables, especially the surface in contact with metal.	6 months after commissioning and then once or twice a year
General status of the system	<ul style="list-style-type: none"> <li>• Visual check for any damage or deformation of the microinverter.</li> <li>• Check any abnormal noise during the operation.</li> <li>• Check each operation parameter.</li> <li>• Be sure that nothing covers the heat sink of the device.</li> </ul>	Every 6 months

# 12 Appendix

## 12.1 Technical Data

Parameter	MG5RL	MG6RL
<b>Input (DC)</b>		
Recommended max. PV input power	10000 Wp	12000 Wp
Max. usable PV input power	8000 Wp	9600 Wp
Max. PV input voltage*	500 V	
Min. PV input voltage / Startup input voltage	40 V/50 V	
Rated PV input voltage	360 V	
MPPT operating voltage range	40 V–425 V	
Full load MPPT voltage range	230 V–425 V	230 V–425 V
No. of independent MPP trackers	2	
No. of PV strings per MPPT	1 / 1	
Max. PV input current	40 A(20 A/20 A)	
Max. DC short-circuit current	50 A(25 A/25 A)	
Max. current for input connector	25 A	
<b>Battery data</b>		
Battery type	Li-ion battery, lead-acid battery	
Battery voltage range	40 V-60 V	
Max. charge / discharge current	120 A/120 A	135 A/135 A
Max. charge / discharge power	5000 W/5000 W	6000 W/6000 W
<b>Input / Output (AC)</b>		
Max. AC power from grid	8800 W	

Parameter	MG5RL	MG6RL
Rated AC output power	5000 W	6000 W
Max. AC output apparent power	5000 VA	6000 VA
Max. AC output current	22.7 A	27.3 A
Rated AC voltage	220 V/230 V/240 V	
AC voltage range	154 V–276 V	
Rated grid frequency	50 Hz/60 Hz	
Grid frequency range	45 Hz–55 Hz/55 Hz–65 Hz	
Harmonic (THD)	<3 % (of rated power)	
Power factor at rated power / Adjustable power factor	>0.99 at default value at rated power / 0.8 leading to 0.8 lagging	
Feed-in phases / Connection phases	1/1	
<b>Backup Data (on grid mode)</b>		
Max. output power for backup load	8800 W	
Max. output current for backup load	40 A	
<b>Backup Data (off-grid mode)</b>		
Rated voltage	220 V/230 V/240 V	
Rated frequency	50 Hz/60 Hz	
THDV(@Linear load)	< 2%	
Backup switch time	≤ 4 ms	
Rated output power	5000 W	6000 W
Max. output power for backup load	5500 W	6600 W
Peak output power	2 times of rated power, 10 s	
<b>Efficiency</b>		
Max. efficiency / European efficiency	97.6%/96.7%	

Parameter	MG5RL	MG6RL
<b>Protection &amp; Function</b>		
Grid monitoring		Yes
DC reverse polarity protection		Yes
AC short-circuit protection		Yes
Leakage current protection		Yes
DC switch (solar)		Yes
Surge protection	DC Type II /AC Type II	
PID Zero		Yes
Micro-inverter compatibility **		Optional
Arc fault circuit interrupter (AFCI)		Optional
<b>General Data</b>		
Topology (Inverter)	Non-isolated	
Topology (Battery BDC)	Isolated	
Degree of protection	IP65	
Dimensions (W * H * D)	532 mm * 386 mm * 210 mm	
Weight	≤18 kg	
Mounting method	Wall-mounting bracket	
Operating ambient temperature range	-25 °C to 60 °C	
Allowable relative humidity range	0%–95%	
Cooling method	Natural convection	
Max. operating altitude	2000 m	
Noise (typical)	< 35 dB(A)	
Display	LCD digital touchable display & LED indicator	
Communication	CAN, RS485, Ethernet (optional), WLAN (optional)	

Parameter	MG5RL	MG6RL
DI / DO	DI * 1 / DO * 1	
DC connection type	MC4 (Max.6 mm <sup>2</sup> )	
Battery connection type	OT terminal (35 mm <sup>2</sup> –50 mm <sup>2</sup> )	
AC connection type	Plug and Play (Max.8 AWG)	
Grid compliance	IEC 62109-1/-2, IEC/EN 61000-6-1/-3, IEC 62116, IEC 61727, NRS 097-2-1, MEA, PEA, DEWA	

Parameter	MG8RL	MG10RL
<b>Input (DC)</b>		
Recommended max. PV input power	16000 Wp	20000 Wp
Max. usable PV input power	12800 Wp	16000 Wp
Max. PV input voltage*	500 V	
Min. PV input voltage / Startup input voltage	40 V/50 V	
Rated PV input voltage	360 V	
MPPT operating voltage range	40 V–425 V	
Full load MPPT voltage range	255 V–425 V	255 V–425 V
No. of independent MPP trackers	3	
No. of PV strings per MPPT	1/1/1	
Max. PV input current	60 A(20 A/20 A /20 A)	
Max. DC short-circuit current	75 A(25 A/25 A/25 A)	
Max. current for input connector	25 A	
<b>Battery data</b>		
Battery type	Li-ion battery, lead-acid battery	
Battery voltage range	40 V–60 V	
Max. charge / discharge current	190A / 190A	220 A / 220 A
Max. charge / discharge power	8000 W / 8000 W	10000 W / 10000 W

Parameter	MG8RL	MG10RL
<b>Input / Output (AC)</b>		
Max. AC power from grid	13860 W	
Rated AC output power	8000 W	10000 W
Max. AC output apparent power	8000 VA	10000 VA
Max. AC output current	36.4 A	45.5 A
Rated AC voltage	220 V/230 V/240 V	
AC voltage range	154V–276V	
Rated grid frequency	50 Hz/60 Hz	
Grid frequency range	45 Hz–55 Hz / 55 Hz–65 Hz	
Harmonic (THD)	<3 % (of rated power)	
Power factor at rated power / Adjustable power factor	>0.99 at default value at rated power / 0.8 leading to 0.8 lagging	
Feed-in phases / Connection phases	1/1	
<b>Backup Data (on grid mode)</b>		
Max. output power for backup load	13860 W	
Max. output current for backup load	63 A	
<b>Backup Data (off-grid mode)</b>		
Rated voltage	220 V/230 V/240 V	
Rated frequency	50 Hz/60 Hz	
THDV(@Linear load)	< 2%	
Backup switch time	≤ 4 ms	
Rated output power	8000 W	10000 W
Max. output power for backup load	8800 W	11000 W
Peak output power	2 times of rated power, 10 s	

Parameter	MG8RL	MG10RL
<b>Efficiency</b>		
Max. efficiency / European efficiency	97.6%/96.7%	
<b>Protection &amp; Function</b>		
Grid monitoring	Yes	
DC reverse polarity protection	Yes	
AC short-circuit protection	Yes	
Leakage current protection	Yes	
DC switch (solar)	Yes	
Surge protection	DC Type II /AC Type II	
PID Zero	Yes	
Micro-inverter compatibility **	Optional	
Arc fault circuit interrupter (AFCI)	Optional	
<b>General Data</b>		
Topology (Inverter)	Non-isolated	
Topology (Battery BDC)	Isolated	
Degree of protection	IP65	
Dimensions (W * H * D)	552 mm * 448mm * 250 mm	
Weight	≤25 kg	
Mounting method	Wall-mounting bracket	
Operating ambient temperature range	-25 °C to 60 °C	
Allowable relative humidity range	0%–95%	
Cooling method	Fan cooling	
Max. operating altitude	2000 m	
Noise (typical)	≤ 45 dB(A)	

Parameter	MG8RL	MG10RL
Display	LCD digital touchable display & LED indicator	
Communication	CAN, RS485, Ethernet (optional), WLAN (optional)	
DI / DO	DI * 1 / DO * 1	
DC connection type	MC4 (Max.6 mm <sup>2</sup> )	
Battery connection type	OT terminal (35 mm <sup>2</sup> –95mm <sup>2</sup> )	
AC connection type	OT terminal (Max.16 mm <sup>2</sup> )	
Grid compliance	IEC 62109-1/-2, IEC/EN 61000-6-1/-3, IEC 62116, IEC 61727, NRS 097-2-1, MEA, PEA, DEWA	
Parameter	MG12RL	
<b>Input (DC)</b>		
Recommended max. PV input power	24000 Wp	
Max. usable PV input power	19200 Wp	
Max. PV input voltage*	500 V	
Min. PV input voltage / Startup input voltage	40 V/50 V	
Rated PV input voltage	360 V	
MPPT operating voltage range	40 V–425 V	
Full load MPPT voltage range	305 V–425 V	
No. of independent MPP trackers	3	
No. of PV strings per MPPT	1/1/1	
Max. PV input current	60 A(20 A/20 A/20 A)	
Max. DC short-circuit current	75 A(25 A/25 A/25 A)	
Max. current for input connector	25 A	
<b>Battery data</b>		
Battery type	Li-ion battery, lead-acid battery	
Battery voltage range	40 V–60 V	

Parameter	MG12RL
Max. charge / discharge current	240 A/240 A
Max. charge / discharge power	12000 W / 12000 W
<b>Input / Output (AC)</b>	
Max. AC power from grid	13860 W
Rated AC output power	12000 W
Max. AC output apparent power	12000 VA
Max. AC output current	54.5 A
Rated AC voltage	220 V/230 V/240 V
AC voltage range	154 V–276 V
Rated grid frequency	50 Hz/60 Hz
Grid frequency range	45 Hz–55 Hz/55 Hz–65 Hz
Harmonic (THD)	<3 % (of rated power)
Power factor at rated power / Adjustable power factor	>0.99 at default value at rated power / 0.8 leading to 0.8 lagging
Feed-in phases / Connection phases	1/1
<b>Backup Data (on grid mode)</b>	
Max. output power for backup load	13860 W
Max. output current for backup load	63 A
<b>Backup Data (off-grid mode)</b>	
Rated voltage	220 V/230 V/240 V
Rated frequency	50 Hz/60 Hz
THDV(@Linear load)	< 2%
Backup switch time	≤ 4 ms
Rated output power	12000 W

Parameter	MG12RL
Max. output power for backup load	12000 W
Peak output power	1.7 times of rated power, 10 s
<b>Efficiency</b>	
Max. efficiency / European efficiency	97.6%/96.7%
<b>Protection &amp; Function</b>	
Grid monitoring	Yes
DC reverse polarity protection	Yes
AC short-circuit protection	Yes
Leakage current protection	Yes
DC switch (solar)	Yes
Surge protection	DC Type II /AC Type II
PID Zero	Yes
Micro-inverter compatibility **	Optional
<b>General Data</b>	
Topology (Inverter)	Non-isolated
Topology (Battery BDC)	Isolated
Degree of protection	IP65
Dimensions (W * H * D)	552 mm * 448mm * 250 mm
Weight	≤25 kg
Mounting method	Wall-mounting bracket
Operating ambient temperature range	-25 °C to 60 °C
Allowable relative humidity range	0%–95%
Cooling method	Fan cooling
Max. operating altitude	2000 m

Parameter	MG12RL
Noise (typical)	≤ 45 dB(A)
Display	LCD digital touchable display & LED indicator
Communication	CAN, RS485, Ethernet (optional), WLAN (optional)
DI / DO	DI * 1 / DO * 1
DC connection type	MC4 (Max.6 mm <sup>2</sup> )
Battery connection type	OT terminal (35 mm <sup>2</sup> –95mm <sup>2</sup> )
AC connection type	OT terminal (Max.16 mm <sup>2</sup> )
Grid compliance	IEC 62109-1/-2, IEC/EN 61000-6-1/-3, IEC 62116, IEC 61727, NRS 097-2-1, MEA, PEA, DEWA

## 12.2 Quality Assurance

When product faults occur during the warranty period, SUNGROW will provide free service or replace the product with a new one.

The software security update period for this product aligns with the warranty period. During the warranty, security patches or updates will be provided if any vulnerabilities or compatibility issues are identified.

### Evidence

During the warranty period, the customer shall provide the product purchase invoice and date. In addition, the trademark on the product shall be undamaged and legible. Otherwise, SUNGROW has the right to refuse to honor the quality guarantee.

### Conditions

- After replacement, unqualified products shall be processed by SUNGROW.
- The customer shall give SUNGROW a reasonable period to repair the faulty device.

### Exclusion of Liability

In the following circumstances, SUNGROW has the right to refuse to honor the quality guarantee:

- The free warranty period for the whole machine/components has expired.
- The device is damaged during transport.
- The device is incorrectly installed, refitted, or used.
- The device operates in harsh conditions beyond those described in this manual.

- The fault or damage is caused by installation, repairs, modification, or disassembly performed by a service provider or personnel not from SUNGROW.
- The fault or damage is caused by the use of non-standard or non-SUNGROW components or software.
- The installation and use range are beyond stipulations of relevant international standards.
- The damage is caused by unexpected natural factors.

For faulty products in any of above cases, if the customer requests maintenance, paid maintenance service may be provided based on the judgment of SUNGROW.



Product data such as product dimensions are subject to change without prior notice. The latest documentation from SUNGROW should take precedence in case of any deviation.

## 12.3 Contact Information

In case of questions about this product, please contact us. We need the following information to provide you the best assistance:

- Model of the device
- Serial number of the device
- Fault code/name
- Brief description of the problem

For detailed contact information, please visit: <https://en.SUNGROWpower.com/contactUS>

**SUNGROW**

Sungrow Power Supply Co., Ltd.

[www.sungrowpower.com](http://www.sungrowpower.com)